

Panasonic



TX-32DK1L

Colour Television



Operating Instructions

WELCOME

Dear Panasonic Customer,

Welcome to the Panasonic family of customers. We hope that you have many years of enjoyment from your new colour television. This is a very advanced television; however, the Quick Start Guide will allow you to use the TV as quickly as possible. You can then read the instructions completely and retain them for future reference.

CONTENTS



| | | | |
|---|-----------|---|-----------|
| Warnings and Precautions | 3 | Tuning Menu - Manual tuning | 24 |
| Accessories | 4 | Tuning Menu - Owner I.D. | 25 |
| Inserting the Remote Control Batteries | 4 | AV Select and Setup | 26 |
| Basic Controls | 5 | Q-Link | 27 |
| Quick Start Guide | 6 | VCR and Satellite Receiver Installation | 29 |
| Using the On Screen Displays | 12 | VCR/DVD Operation | 30 |
| Aspect Control | 13 | Teletext Operation | 31 |
| Picture Menu | 15 | Audio / Video (AV) Connections | 33 |
| Sound Menu | 16 | Via the front AV3 4 pin S-Video, RCA Audio / Video and Headphone sockets | 33 |
| Setup Menu | 17 | Scart and S-Video socket information | 33 |
| Tuning Menu - overview | 18 | Via the rear AV1 / AV2(S) 21 Pin Scart and RCA Audio Out terminals | 34 |
| Tuning Menu - Programme edit | 19 | Troubleshooting | 35 |
| Tuning Menu - Auto setup | 23 | For your guidance | 36 |
| | | Specifications | 36 |

WARNINGS AND PRECAUTIONS

- This TV set is designed to operate on 220–240V, 50Hz A.C.
- To prevent damage which might result in electric shock or fire, do not expose this TV set to rain or excessive moisture.
- **WARNING : HIGH VOLTAGE !!!**
Do not remove the rear cover as live parts are accessible when it is removed. There are no user serviceable parts inside.
- Avoid exposing the TV set to direct sunlight and other sources of heat.
- The On/Off switch on this model does not fully disconnect the TV from the mains supply. Remove the mains plug from the wall socket when the TV set is not used for a prolonged period of time.
- **CABINET AND PICTURE TUBE CARE**
Remove the mains plug from the wall socket. The cabinet and picture tube can be cleaned with a soft cloth moistened with mild detergent and water. Do not use solutions containing benzol or petroleum. TV sets can produce static electricity, care must be taken whenever touching the TV screen.
- Adequate ventilation is essential to prevent failure of electrical components, we recommend that a gap of at least 5cm is left all around this television receiver even when it is placed inside a cabinet or between shelves.

FOR YOUR SAFETY PLEASE READ THE FOLLOWING TEXT CAREFULLY

This appliance is supplied with a fitted three pin mains plug for your safety and convenience. A 5 amp fuse is fitted in this plug. If the fuse is replaced then the replacement fuse must be 5 amp rated and should be approved by ASTA or BSI to BS1362.

Check for the ASTA mark  or the BSI mark  on the body of the fuse.

If the fitted plug has a removable fuse cover you must ensure that it is refitted when the fuse is replaced. If you lose the fuse cover the plug must not be used until a replacement cover is obtained. Replacement fuse covers can be purchased through your local Panasonic dealer.

The plug fitted to this appliance incorporates a mains filter circuit. If this is removed or replaced with a non-filtered plug this television will no longer meet the European standards for Electromagnetic Compatibility (EMC). If the fitted plug is unsuitable for the socket outlet in your home an appropriate adapter should be used.

Nonetheless, if the fitted plug is replaced, the fuse should be taken out and the cut-off plug disposed of safely. There is danger of severe electrical shock if the cut off plug is inserted into any 13 amp socket.

If a new plug is to be fitted please observe the wiring code as shown below.
If in any doubt please consult a qualified electrician.

How to replace the fuse (for plug type shown in example 1) :

Lift out the removable fuse compartment with a screwdriver and replace the fuse, then refit securely into the mains plug (see example 1).

How to replace the fuse (for plug type shown in example 2) :

Lift open the fuse compartment, in the mains plug, with a screwdriver, and replace the fuse, then press the fuse cover down securely (see example 2).

Example 1

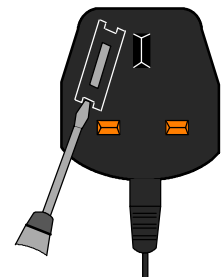

Example 2

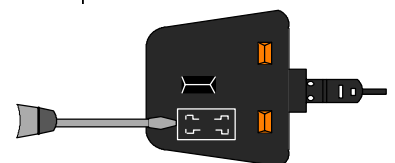

IMPORTANT :- The wires in the mains lead of this appliance are coloured in accordance with the following code :-

BLUE : NEUTRAL

BROWN : LIVE

As the colours of the wires in the mains lead of this appliance may not correspond to the markings identifying the terminals in your plug, proceed as follows :-

1. The **BLUE** wire must be connected to the terminal marked 'N' or coloured black.
2. The **BROWN** wire must be connected to the terminal marked 'L' or coloured red.

IMPORTANT NOTE : Under no circumstances should either of these wires be connected to the Earth terminal of the three pin plug, marked with the letter 'E' or the earth symbol. 

ACCESSORIES

Check that you have the accessories and items shown 



Operating Instruction book
TQB8E2915

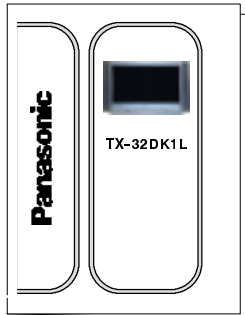

Remote Control
Transmitter
EUR511210



TV Guarantee



VS - DK1/2
(Video cabinet)



Batteries for the Remote Control
Transmitter.
(2 x R6 (UM3) size)



INSERTING THE REMOTE CONTROL BATTERIES

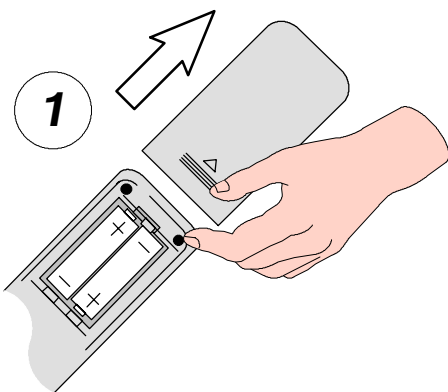

Slide off the battery cover

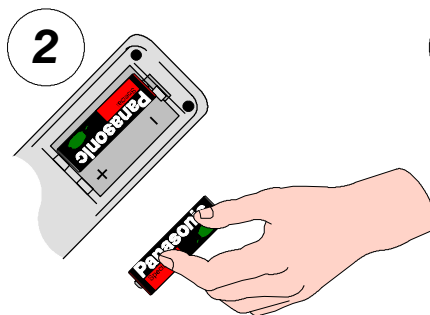

Insert batteries - note correct polarity
(+ and -)

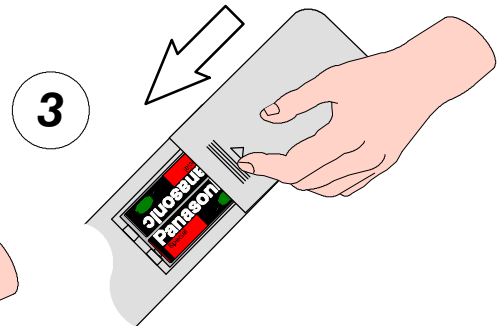

Replace the cover

Notes:

- Make sure that the batteries are fitted the correct way round.
- Do not mix old batteries with new batteries. Remove old, exhausted batteries immediately.
- Do not mix different battery types, i.e. Alkaline and Manganese. Do not use rechargeable (Ni-Cad) batteries.

BASIC CONTROLS : FRONT PANEL AND REMOTE CONTROL

Press here and open flap to expose TV controls, front AV3 and headphone terminals

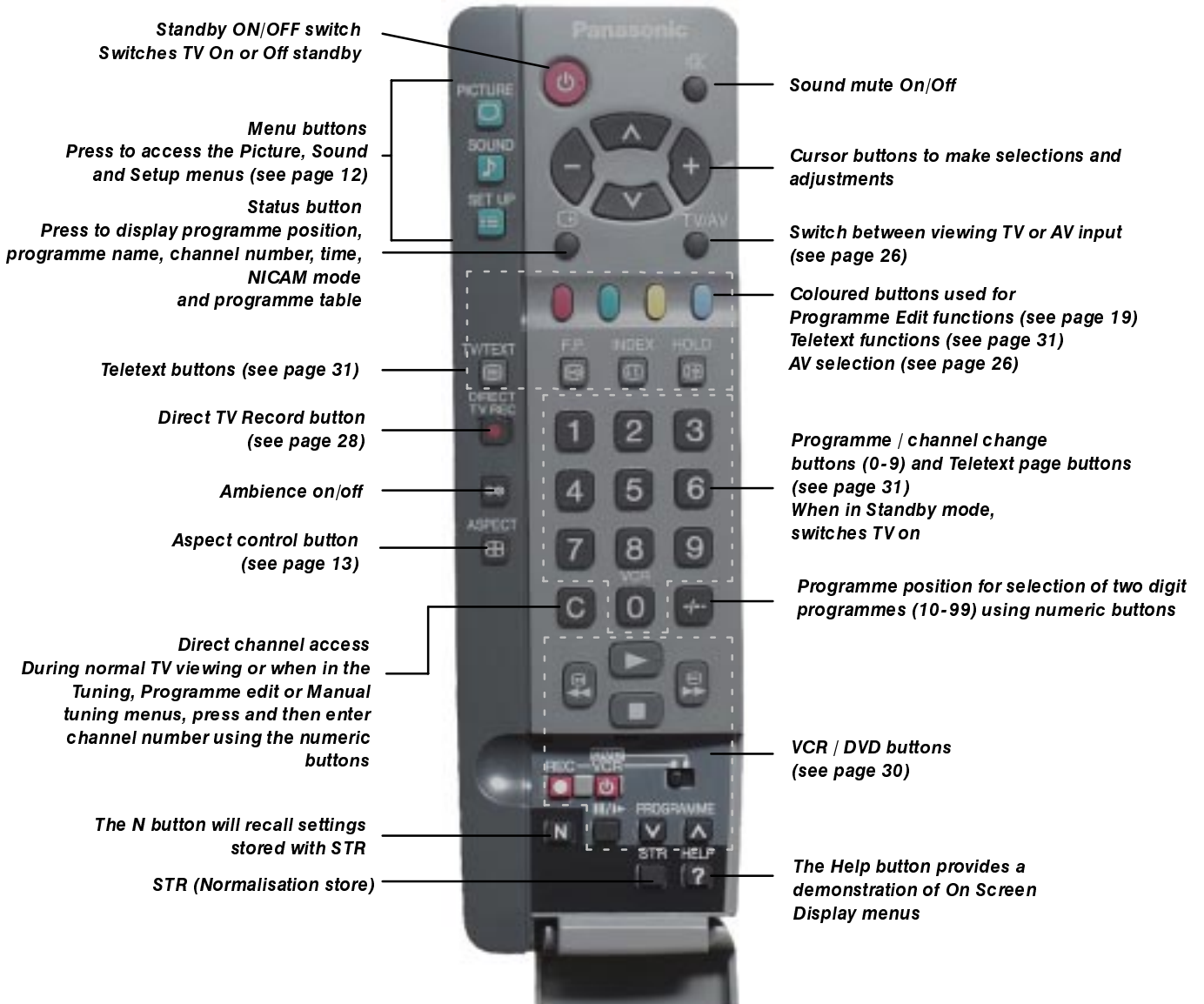
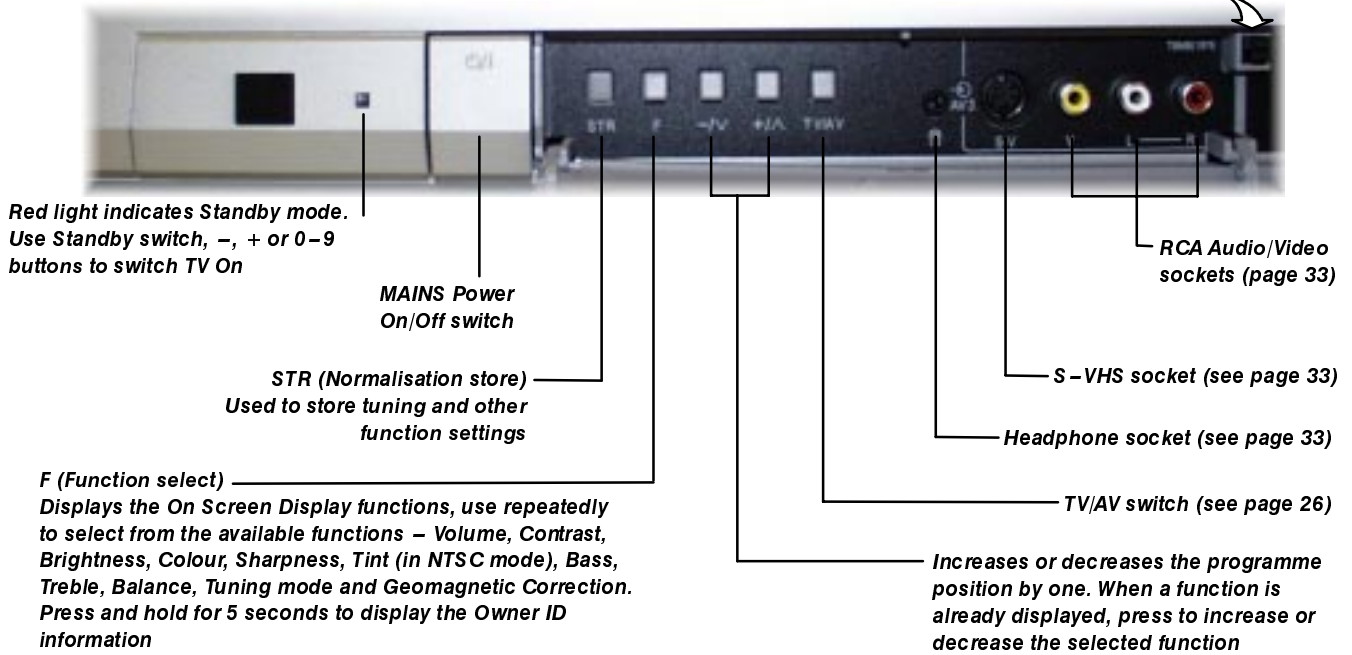

QUICK START GUIDE

Connection and setting up options

1. If connecting the TV using an RF cable only, proceed to option 1.
2. If connecting the TV using Scart and RF cables, proceed to option 2.
3. If connecting the TV to a Q-Link (or Q-Link compatible) VCR, proceed to option 3 on page 7.
4. If connecting the TV to a Q-Link (or Q-Link compatible) VCR and a Satellite Receiver, proceed to option 4 on page 8.

1. Connection of TV using an RF cable only

RF Connection

- Connect the RF cable into the TV Aerial socket ().

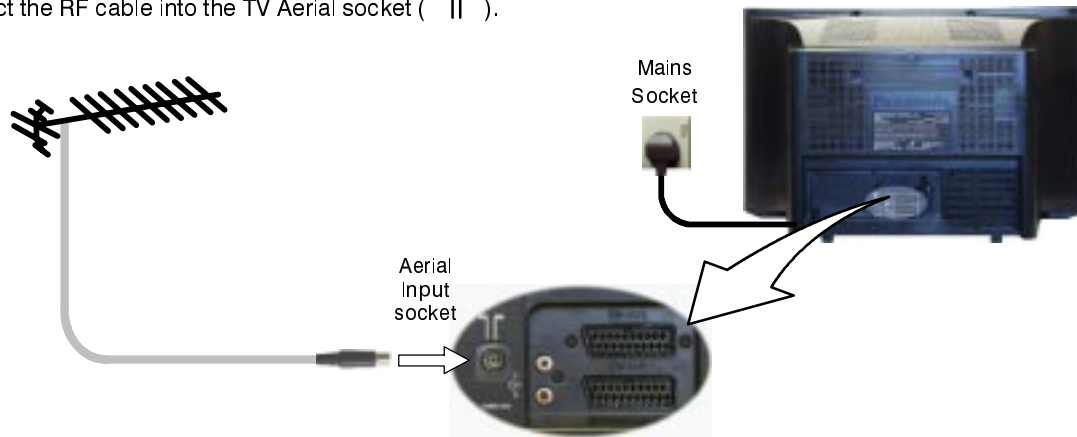

2. Connection of TV and VCR using Scart and RF cables

Scart Connections

- The VCR can also be connected to the TV using a Scart cable if you are using a Scart equipped VCR.
- Use the TV's AV1 Scart socket for a VCR.
- Use the TV's AV2S Scart socket for an S-Video VCR.

RF Connection

- Connect the RF cable to the Aerial In socket of the VCR and an RF cable from the VCR Aerial Out socket to the TV Aerial socket ().

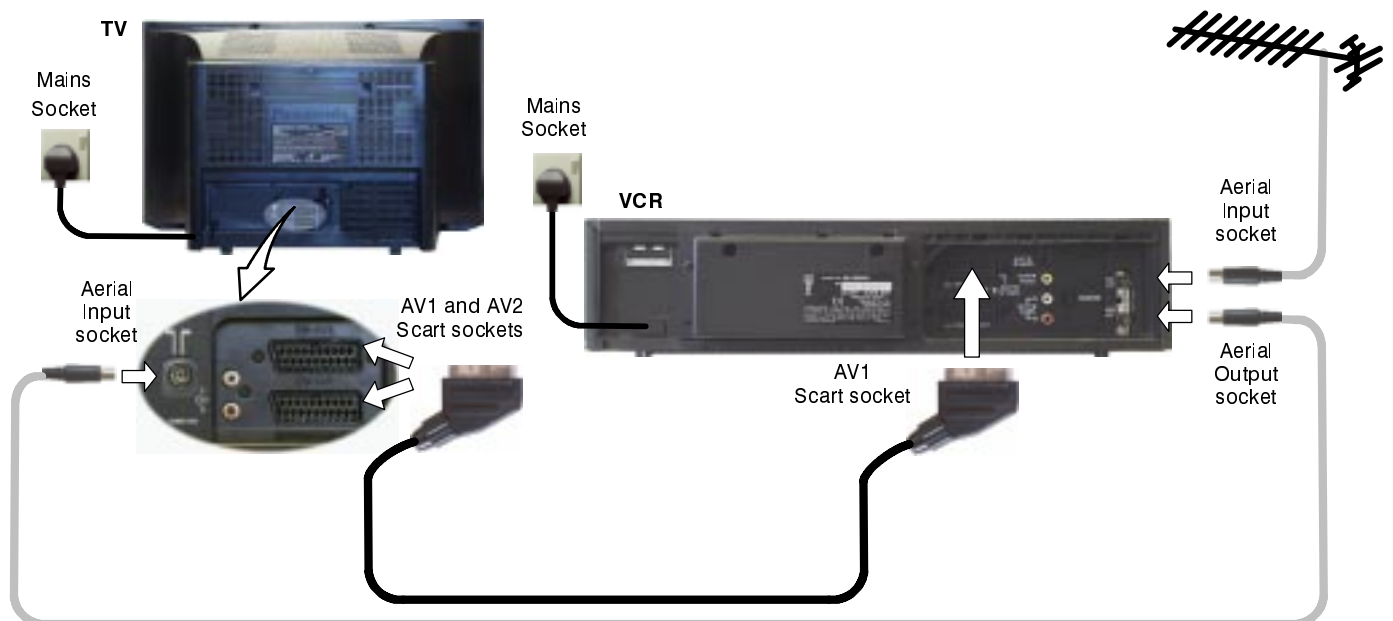

Notes :

Additional equipment and cables are not supplied.
Further details of Audio/ Video connections can be found on pages 33 and 34.

What is Q-Link ?

Q-Link allows direct communication between the TV and a Q-Link (or Q-Link compatible) VCR, this will enable features such as downloading of tuning information from the TV to the VCR.

When using a "NEXTVIEWLINK" VCR the main features possible are the following :

- *Preset Download* - Downloading of tuning information from the TV to the VCR.
- *Direct TV Record* - For immediate recording of the current program (What You See Is What You Record).

When using a "Q-Link" VCR the main features possible are the following :

- *Preset Download* - Downloading of tuning information from the TV to the VCR.
- *Direct TV Record* - For immediate recording of the current program (What You See Is What You Record).
- *TV/VCR Auto Power On* - When the VCR plays a tape the TV will automatically switch On and select the AV2 input.
- *VCR Auto Power Standby* - When the TV is switched into Standby, the VCR will also switch into Standby.
- *VCR Image view On* - If the TV is in Standby mode and the VCR sends a menu to be displayed on the TV screen (e.g. Main menu), the TV will automatically switch On and the menu will be displayed.

This TV will also communicate with other VCR's that bear the following logos :

- "DATA LOGIC" (a trademark of Metz Corporation).
- "Easy Link" (a trademark of Philips Corporation).
- "Megalogic" (a trademark of Grundig Corporation).
- "SMARTLINK" (a trademark of Sony Corporation).

These VCR's may support some or all of the above functions. Refer to the VCR operating instruction book.

Further information on Q-Link can be found on page 27.

In order for Q-Link to function correctly, the Scart cables must be connected in a certain way, dependent on whether the TV is being connected to a VCR (option 3, below) or to a VCR and Satellite Receiver (option 4, overleaf).

3. Q-Link connection of TV and VCR using Scart and RF cables

Scart Connection

- The VCR must be connected to the AV2 Scart socket of this TV using a "fully wired" Scart cable.

Note :

If using a "Q-Link" VCR then the AV1 Scart of the VCR must be connected to the AV2 socket of the TV. If your VCR is not a "Q-Link" VCR, please consult your VCR operating instruction book.

RF Connection

- Connect the RF cable to the Aerial In socket of the VCR and an RF cable from the VCR Aerial Out socket to the TV Aerial socket ().

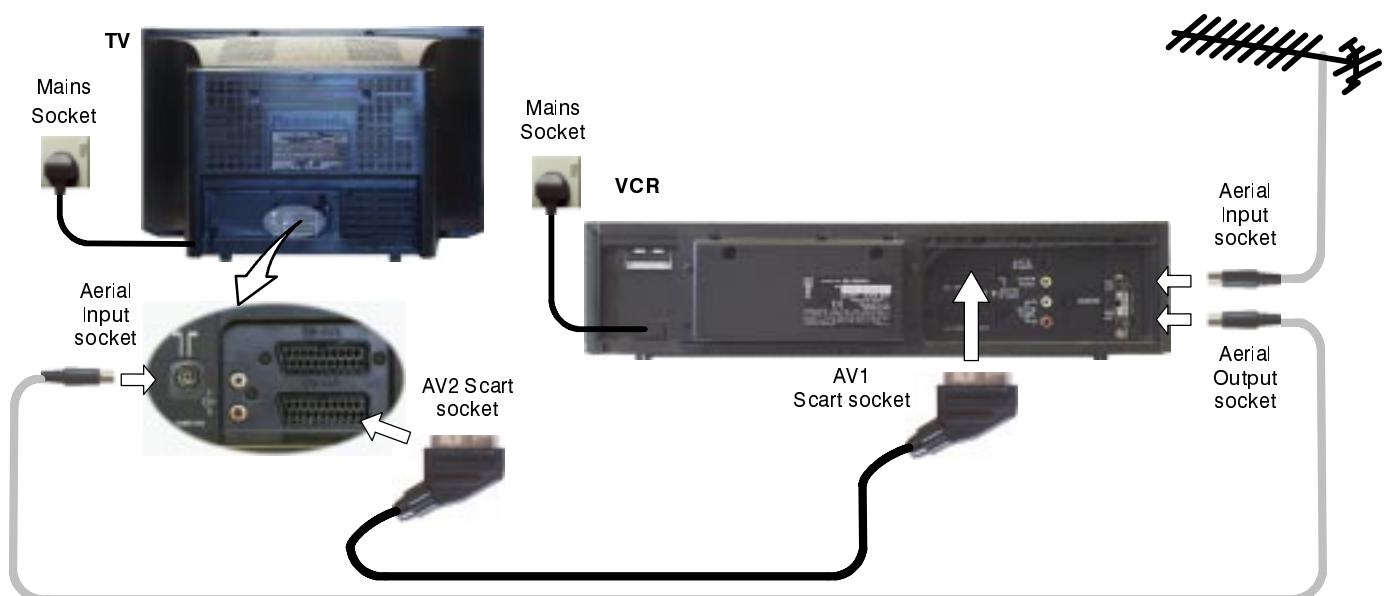

Notes :

Additional equipment and cables are not supplied.

Further details of Audio/ Video connections can be found on pages 33 and 34.

Further information for VCR and Satellite Receiver installation with this TV can be found on page 29.

4. Q-Link connection of TV, VCR and Satellite Receiver using Scart and RF cables

For Q-Link to function correctly the TV, VCR and Satellite Receiver must be connected as shown in the diagram below.

Scart Connections

"Fully wired" Scart cables should be used for all of the Scart connections.

- The AV2 Scart of the VCR must be connected to the VCR socket of the Satellite Receiver.
- The TV Scart socket of the Satellite Receiver must be connected to the AV1 Scart socket of the TV.

Note :

If using a "Q-Link" VCR then the AV1 Scart of the VCR must be connected to the AV2 socket of the TV. If your VCR is not a "Q-Link" VCR, please consult your VCR operating instruction book.

RF Connections

- Connect an RF cable to the Aerial In socket of the Satellite Receiver.
- Connect an RF cable from the RF Out socket of the Satellite Receiver to the RF In socket of the VCR.
- Connect an RF cable from the RF Out socket of the VCR to the TV Aerial In socket (Γ).

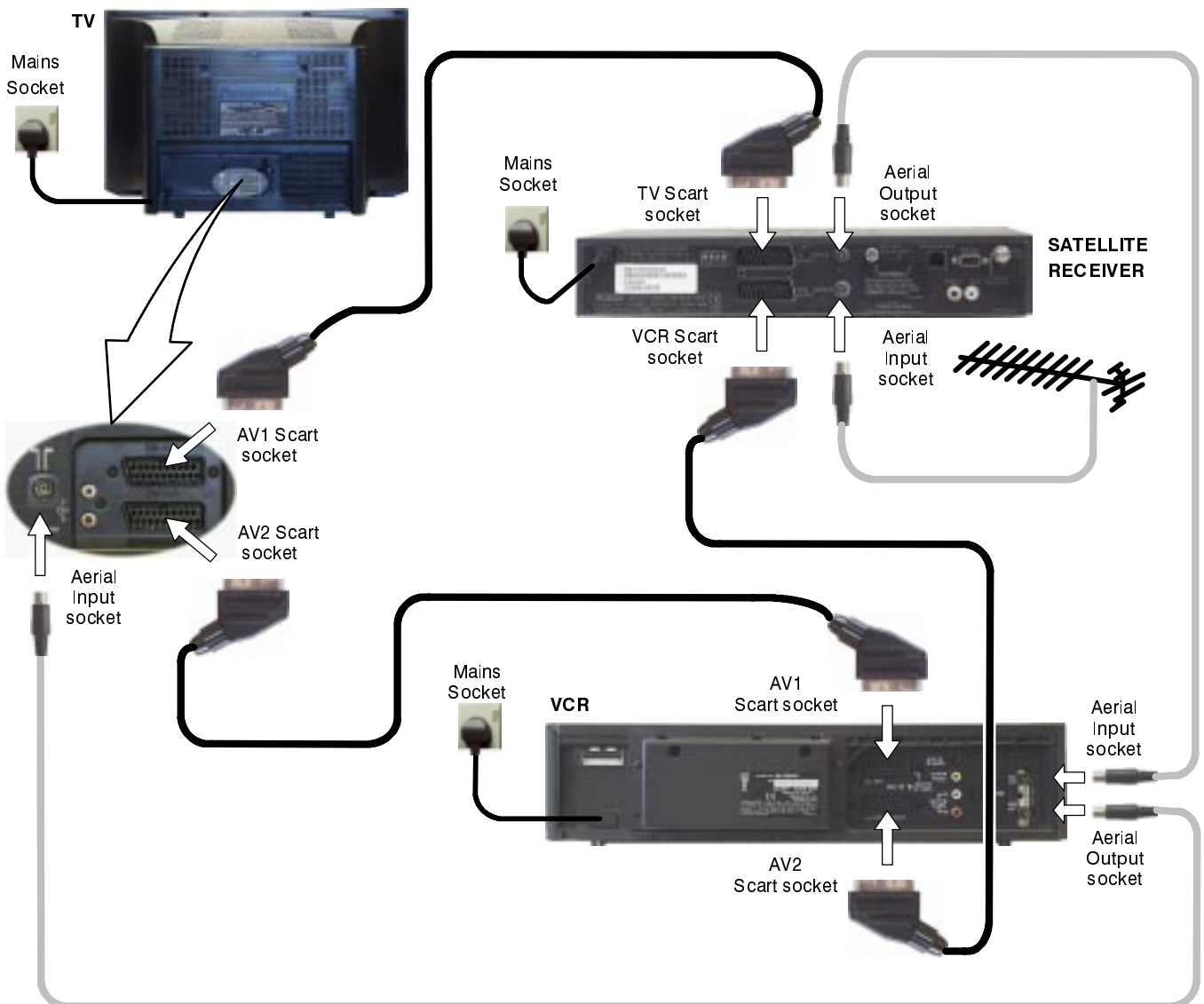

Notes :

Additional equipment and cables are not supplied.

Further details of Audio/ Video connections can be found on pages 33 and 34.

Further information for VCR and Satellite Receiver installation with this TV can be found on page 29.

QUICK START GUIDE

- 1** Ensure that the **VCR is in Standby mode**.
Switch ON your Satellite Receiver; to ensure reliable tuning select either SKY ONE or SKY NEWS.

Plug the TV into mains socket and switch ON.

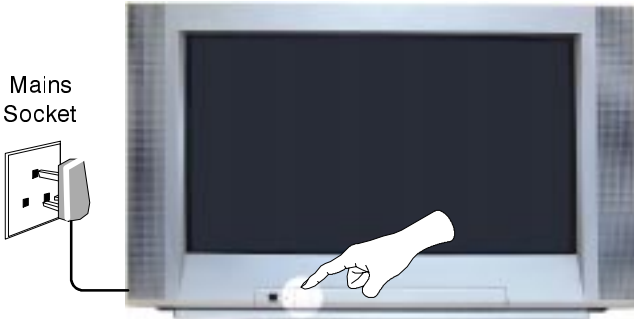

- 2** Programmes will appear immediately if your dealer has programmed the TV for you. If the TV has not been programmed for you then **Auto setup** will begin. TV stations will be located, sorted into order and stored ready for use.



- 3** **Owner ID**
As an added feature, this TV has the option of adding a security code(Owner ID) and personal details into its memory, so that in the unfortunate event of theft it will help the Police to trace the owner.

Enter required 4 digit Owner ID **PIN NUMBER**.
(using 0 to 9 on the remote control).

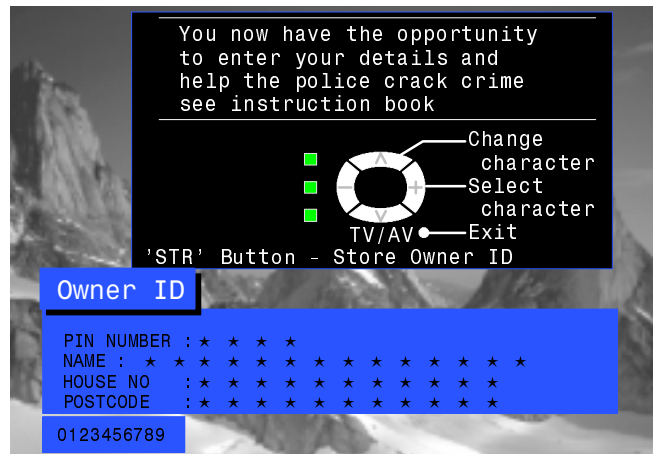

- 4** Enter **NAME, HOUSE NUMBER** and **POSTCODE**.

If a 4 digit **PIN NUMBER** was entered above, you will be taken automatically to the **NAME** line.

If not, move to the **NAME** line.

Change character.

Select character position.

Repeat above until **NAME, HOUSE NUMBER** and **POSTCODE** are entered.

Press **STR** to store the details.

Press **STR** again, when you are asked "Are you sure ?"

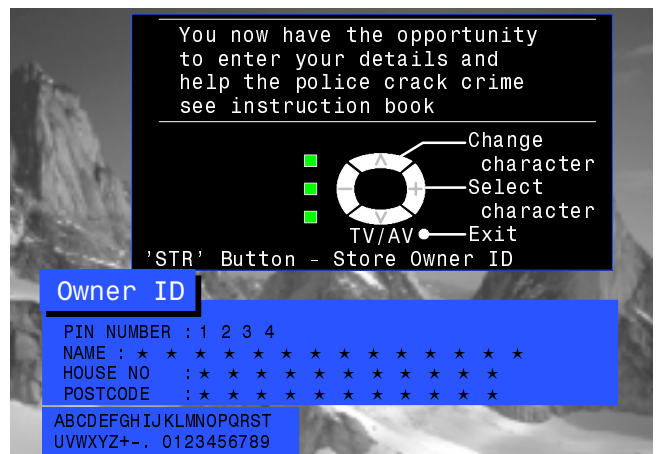

For further information on Owner I.D., see page 25.

A space is provided on page 25 to write down the **PIN NUMBER** for future reference.

5

TV to VCR Download

If a "Q-Link", "NEXTVIEWLINK" or compatible VCR has been connected to the AV2 socket before starting Step 1, programme information will be downloaded to the VCR.

Downloaded tuning information will match the television's.

Not all VCRs support this download of programme information, some may require to be started manually. Refer to the VCR operating instruction book.



If a VCR other than those described above has been connected, then there will be no download operation, the TV is now ready for use:

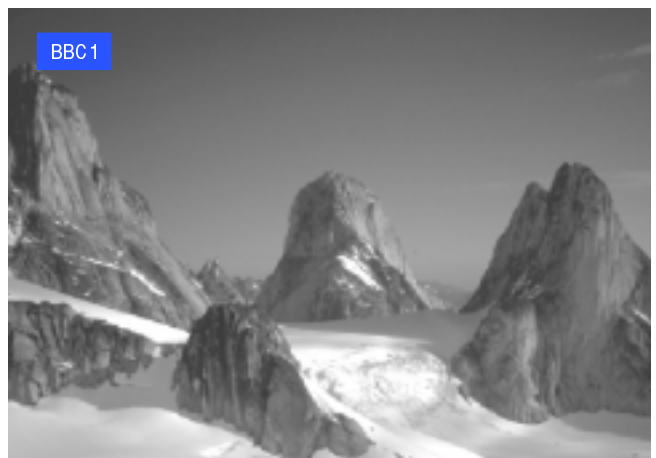

Notes :

If the VCR has not accepted download data from the TV, you may need to select the Download option from the VCR's menu system. Refer to the VCR operating instruction book.

If Q-Link is not operating correctly, check the following :

- The Scart cable is connected to the TV's AV2 Scart socket.
- The Scart cable is connected to the VCR's compatible (Q-Link, NEXTVIEWLINK or similar technology) Scart socket.
- The Scart cable is a "fully wired" type.

For further information on Q-Link and connecting equipment, see pages 27, 33 and 34.

- The sorted programme order depends upon the TV signal, the broadcasting system, and reception conditions. If the order is not to your preference it can be rearranged. Refer to the Programme edit menu - see page 19 for details.

QUICK START GUIDE

6

Slight tilting of the picture may be noticeable or coloured patches may sometimes appear at the corners of the screen (colour purity). The Geomagnetic Correction feature can be used to eliminate them, if necessary:

First, ensure the Auto setup and Q-Link download procedures are complete. The screen should not be showing any On-Screen Display menus.



Open the flap on the television's front panel

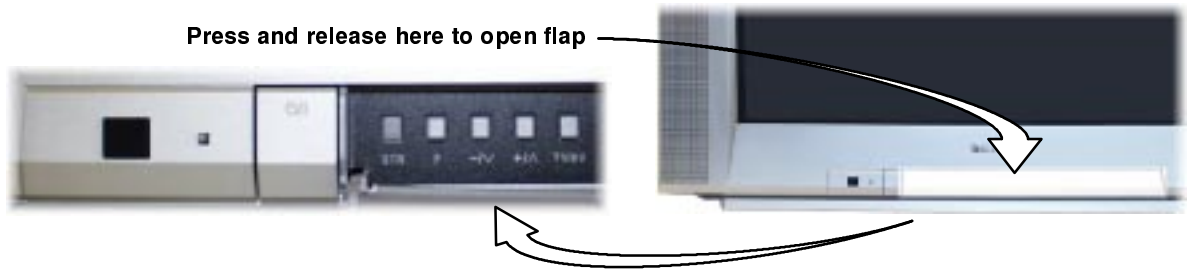

Press the **F** button repeatedly until the Geomagnetic Correction feature is displayed

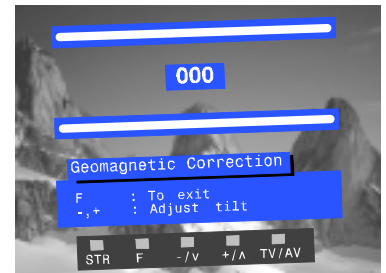

Press the **+** or **-** buttons repeatedly until the picture appears to be level

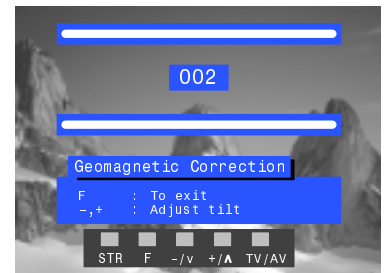
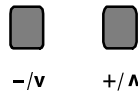

Press the **F** button again to return to normal viewing. Close the flap to prevent damage



7

You are now ready to begin viewing programmes

The cursor controls provide the two basic functions:

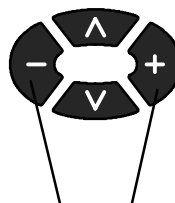

Adjust Volume

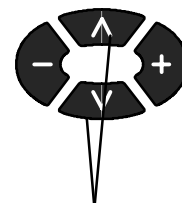

Change Programme

USING THE ON SCREEN DISPLAYS

This TV has a comprehensive system of On Screen Display menus to access adjustments and options

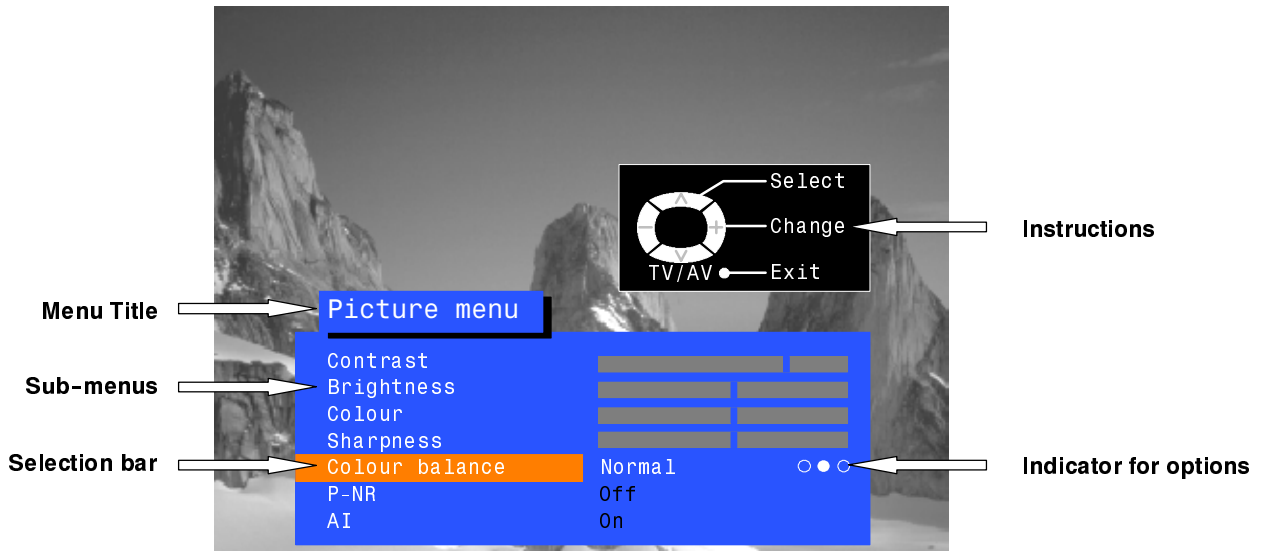

Some selections, for example, **Contrast**, **Brightness**, **Colour** and **Sharpness** will allow you to increase or decrease their level.

Some selections, for example, **Off timer**, allow a change of setting to be made.

Some selections, for example **Tuning menu**, will lead to a further menu.

The **PICTURE**, **SOUND** and **SET UP** buttons are used to open the main menus and also to return to the previous menu.



The up and down cursor buttons are used to move the cursor up and down the menu.



The left and right cursor buttons are used to access menus, adjust levels or to select from a range of options.

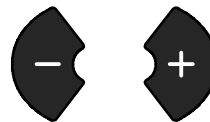

The **STR** button is used to store settings after adjustments have been made or options have been set.



The **TV/AV** button is used to exit the menu system and return to the normal viewing screen.



The **HELP** button will run a demonstration of the menus available. Press the **HELP** button and select one of the options.



If the **HELP** button is pressed whilst a menu is displayed, the 'Instructions' box will be hidden from view. Press the **HELP** button again to show the 'Instructions' box.



ASPECT CONTROLS

The widescreen TV will allow you to enjoy viewing the picture at its maximum size, including widescreen 'cinema format' pictures.

Note: Just mode is not available when viewing an RGB source.

Press the **ASPECT** button to move through the five aspect options: **Panasonic Auto**, **4:3**, **Zoom**, **16:9 (Full)** and **Just**

ASPECT



Panasonic Auto

Some broadcasts are transmitted together with a wide screen identification signal (WSS). If the TV receives this signal then it will automatically switch to wide screen 16:9 mode, maximum display.

The automatic widescreen switching depends upon reception conditions and the strength of the signal. If the signal is poor and therefore the WSS is weak then it is possible that the picture may not expand to 16:9 (full) size and that the TV will display black areas around the edges.

If the original source signal was a standard 4:3 aspect ratio then you might prefer to view it in its original size; the red and green keys that appear will allow you to choose between viewing at standard **4:3** size or expanded in **Just** mode.

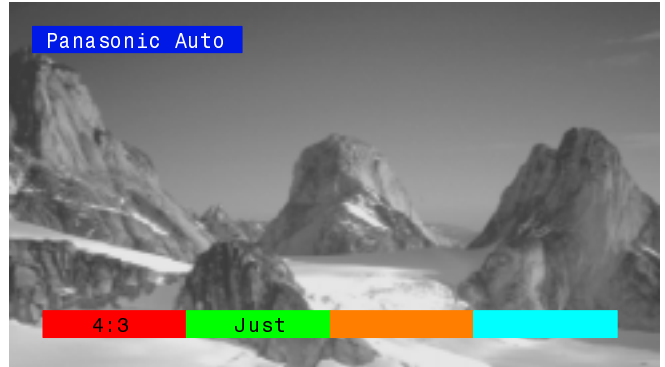

Panasonic Auto

4:3

4:3 will display a 4:3 picture at its standard 4:3 size and can be selected if you wish to view in this format.

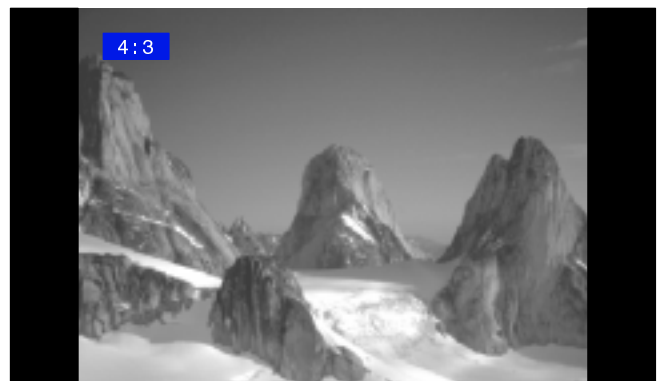

4:3

ASPECT CONTROLS

Zoom

Zoom mode magnifies the central section of the picture.

The picture can be moved and enlarged vertically using the coloured keys. The former adjustment is useful for viewing any sub-titles which may appear outside the picture.

The on screen selector keys that appear for some aspect functions will clear after a few seconds. If you subsequently wish to select an operation then press the Aspect key once more for the keys to reappear.

The widescreen aspect ratios of different films and programmes can vary. If these are wider than a standard 16:9 aspect picture then a black band may be visible at the top and bottom of the screen.

If, in Panasonic Auto mode, you experience problems with the screen display size when playing back widescreen format recordings from your VCR then it is possible that the tracking control of your VCR requires adjustment (your VCR instruction book will contain adjustment details).

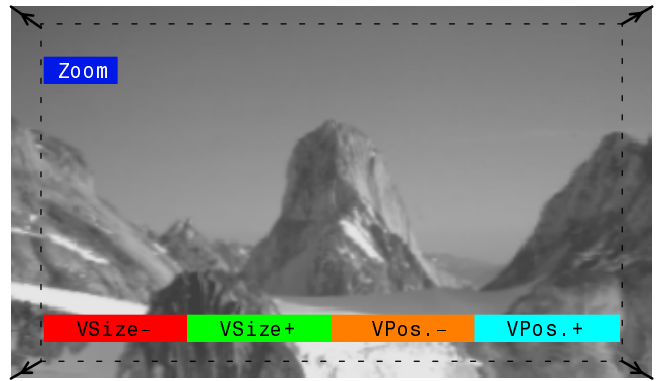

Zoom

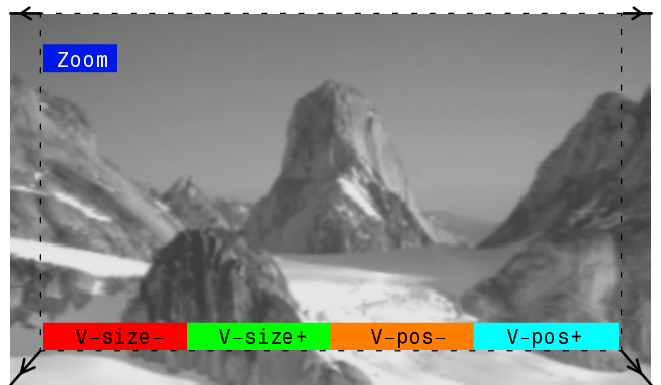

Blue key has been pressed to move picture upwards

16:9 (Full)

16:9 (Full) will display the picture at its maximum size but with slight elongation.



16:9 (Full)

Just

Just mode will display a 4:3 picture at maximum size but with aspect correction applied to the centre of the screen so that elongation is only apparent at the left and right edges of the screen. The size of the picture will depend on the original signal.



Just

PICTURE MENU

Open the Picture menu

PICTURE



Move to your choice



Increase or decrease levels or set options



Press the TV/AV button to exit the Picture menu

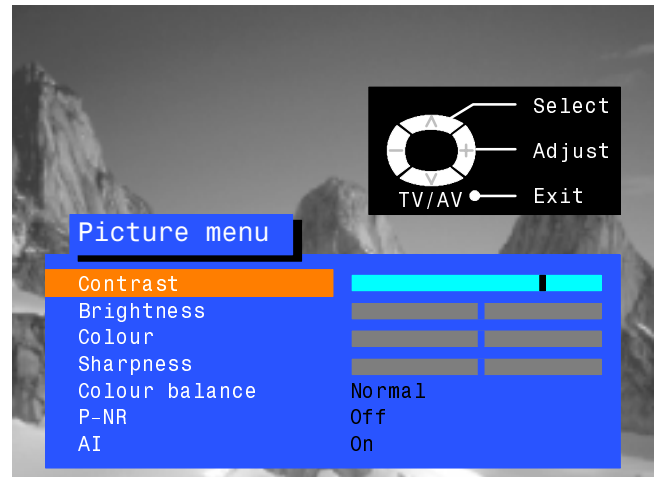

Contrast

Brightness

Colour

Sharpness

Tint

The Contrast, Brightness, Colour and Sharpness levels can be adjusted to suit your own preferences.

The Tint adjustment will only appear as a menu item if you have an NTSC signal source connected to the TV and will allow adjustment of the hue.

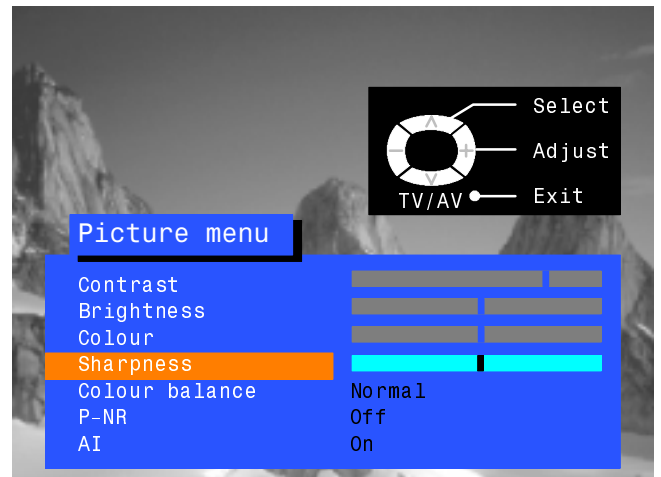

Colour balance



The Colour balance setting allows you to set the overall colour tone of the picture.

P-NR



P-NR will automatically reduce unwanted picture noise.

AI



AI automatically analyses the incoming picture and processes it to give improved contrast and optimum depth of field.



SOUND MENU

Open the Sound menu

SOUND



Move to your choice



Increase or decrease levels or set options



Press the TV/AV button to exit the Sound menu

TV/AV

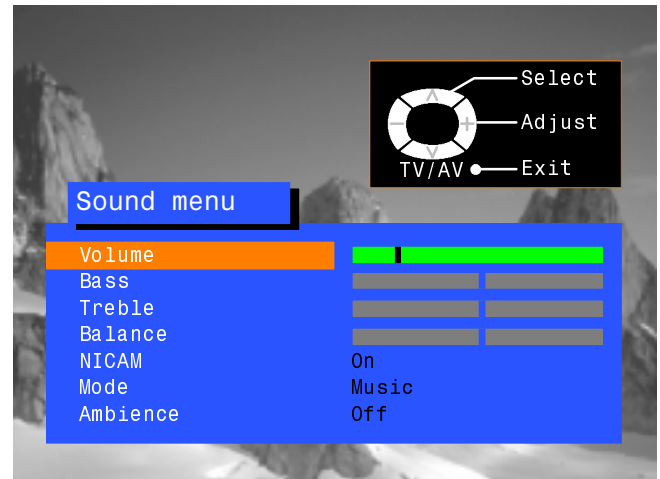

Volume

The Volume adjustment sets the overall output volume.

Bass

Bass adjustment will emphasise the lower, deeper frequencies and can be increased or decreased.

Treble

Treble adjustment will emphasise the sharper, higher frequencies and can be increased or decreased.

Balance

Balance affects the levels of sound between the left and right speakers. Adjustment can be made so that the level from the speakers will suit your listening position.

Select On to provide stereo sound reproduction. Select Off for FM Mono sound output.

NICAM



If Nicam Mono is being transmitted select either FM Mono (Off), Nicam Mono I (M1) or Nicam Mono II (M2). The options depend upon the signal being transmitted.

If reception deteriorates it is advisable to switch to FM Mono (Off).

When Nicam transmissions are not being received the sound will be FM Mono (Off) only.

Mode



The sound can be improved during Music or Speech mode by selecting the appropriate function.

Ambience



Ambience provides a dynamic enhancer to simulate improved spatial effects.

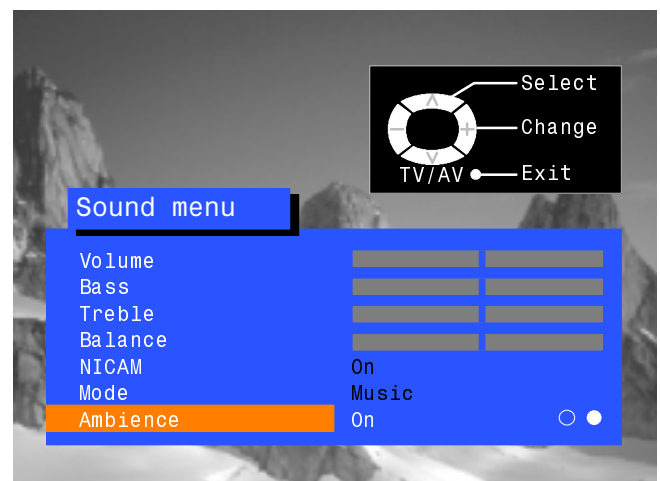
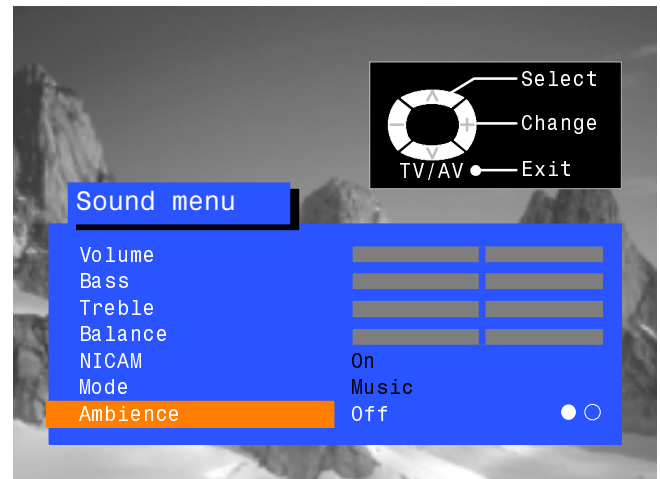

SETUP MENU

The Setup menu provides access to various advanced features and also to the Tuning menu

Open the Setup menu



Move to your choice



Increase or decrease levels, set options or access further menus



Press the TV/AV button to exit the Setup menu

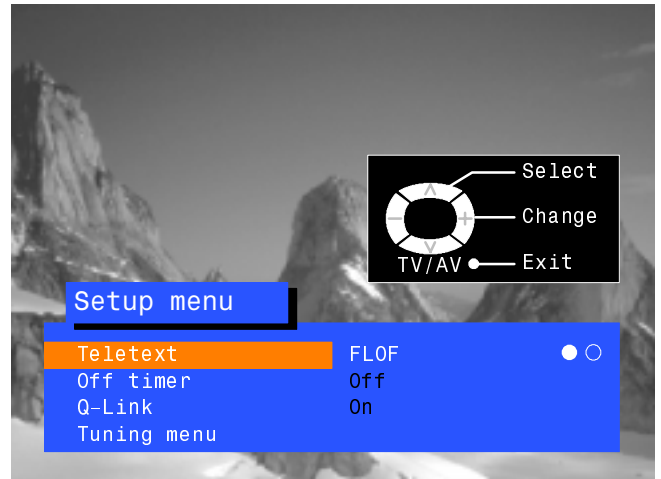

Teletext



The Teletext option allows you to choose between FLOF or LIST mode. See page 31.

Off timer



Off timer will switch the TV off within a preset time which you can choose from between 0 to 90 minutes in 15 minute intervals.

Q-Link



Q-Link allows you to enable or disable data communication with a compatible VCR. See page 27.

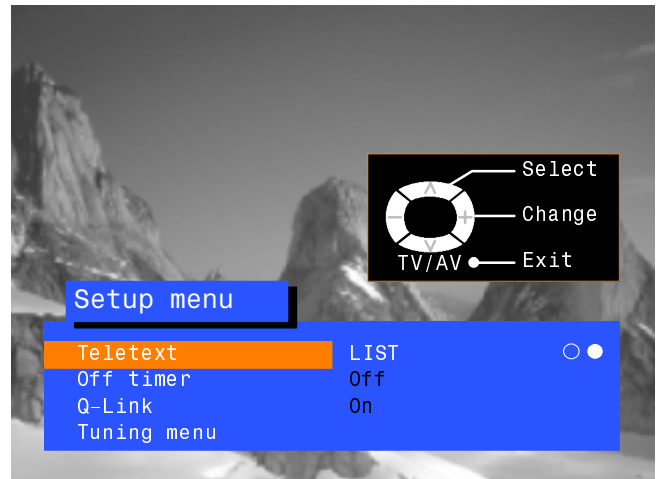

Tuning menu

The Tuning menu provides an entry to many other features including Programme edit and Auto setup. See page 18.

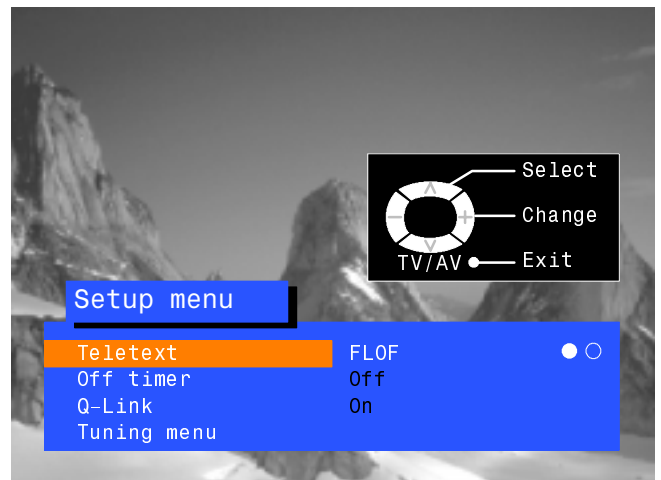

TUNING MENU - overview

Open the Setup menu

SET UP



Move to Tuning menu



Access Tuning menu



Move to your choice



Increase or decrease levels, set options or access further menus



Press the TV/AV button to exit

TV/AV

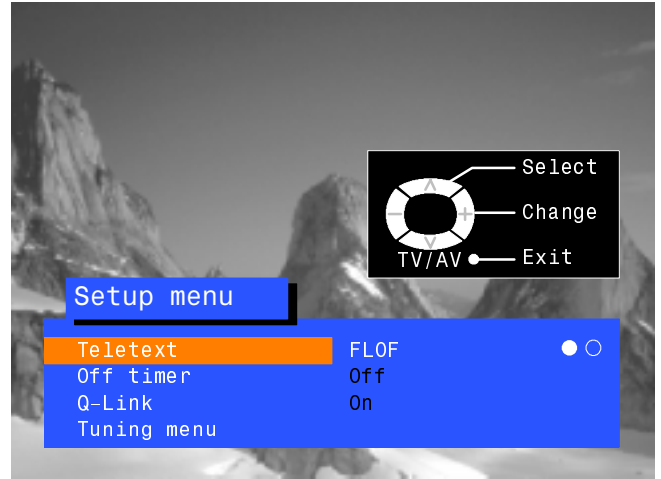

Programme edit

Accessing the Programme edit menu will allow stations to be moved, added, deleted, named or locked. See page 19.



Auto setup

The Auto setup menu allows you to automatically retune the TV. See page 23.

Manual tuning

The Manual tuning menu allows individual programme positions to be tuned manually. See page 24.

Fine tuning

Stations can be finely tuned using the Fine tuning adjustment.

Volume correc.

Volume correction allows you to adjust the volume level of individual stations

Decoder (AV2)



(This function is only displayed and alterable if 'Q - Link' in the 'Setup menu' is switched 'On').

This option is used when a decoder is connected via AV2. Set to On if a scrambled signal is to be processed by the decoder. Set to Off after use.

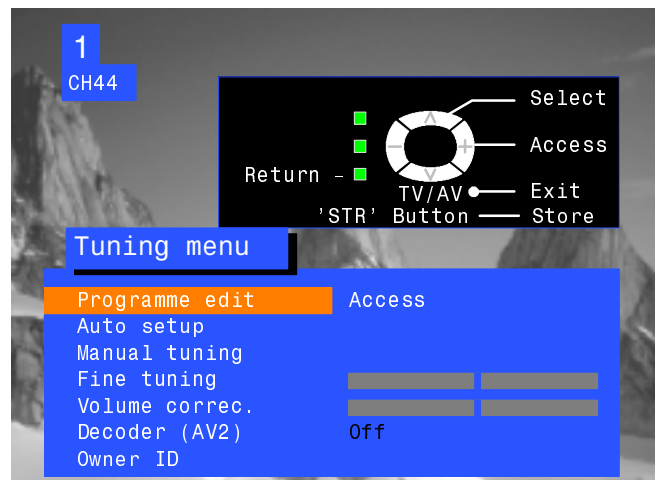

Owner ID

Allows you to enter a security code and address information. See page 25.

TUNING MENU - PROGRAMME EDIT

The Programme edit menu allows you to edit the programme position settings

Open the Setup menu



Move to Tuning menu



Access Tuning menu



Move to Programme edit menu



Access Programme edit menu



Make required changes
(see sections below)

Press STR button to store changes



If you have finished in the Programme edit menu, press the TV/AV button to exit



To delete an unwanted programme position

Ensure that the cursor is in the Prog. Column

Choose the programme position



Press the Red button on remote control



Press the Red button again to confirm



If you have finished in the Programme edit menu, press the TV/AV button to exit

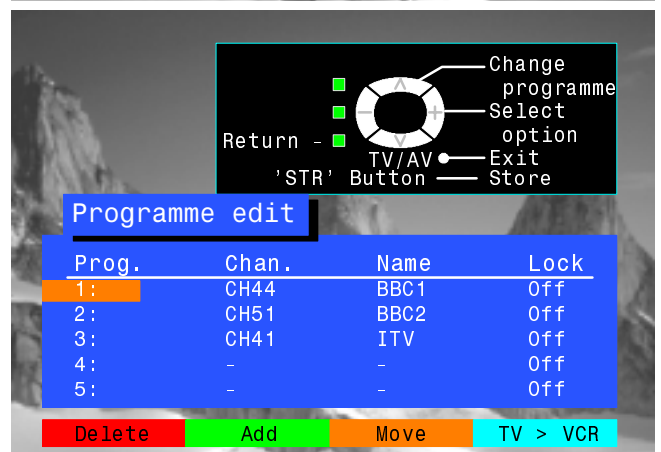
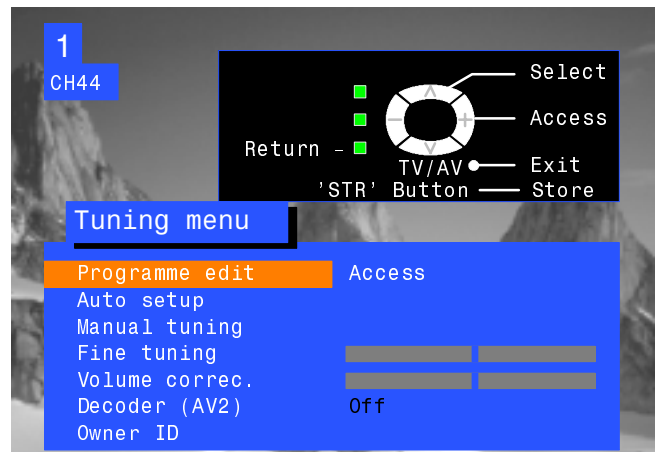
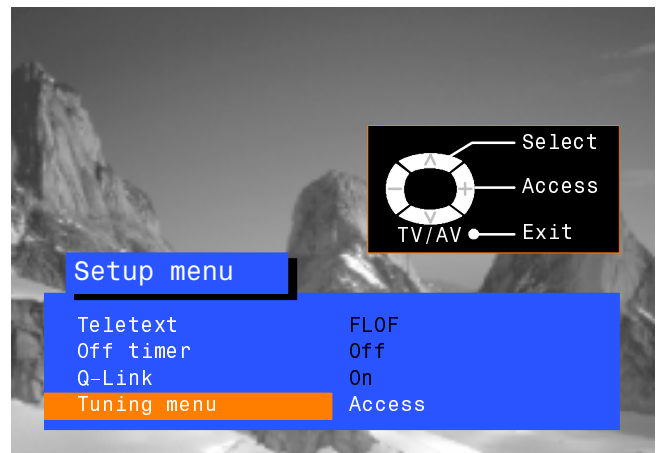
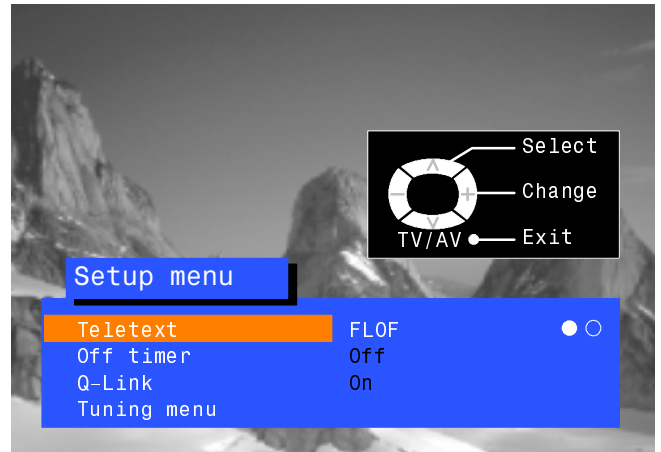

TUNING MENU - PROGRAMME EDIT

To add a programme position

Choose the programme position where the new programme is to be inserted



Press the Green button



Press the Green button again to confirm



This blank programme can then be tuned (see page 24), named (see page 21) or locked (see page 22)

Press STR to store



If you have finished in the Programme edit menu, press the TV/AV button to exit

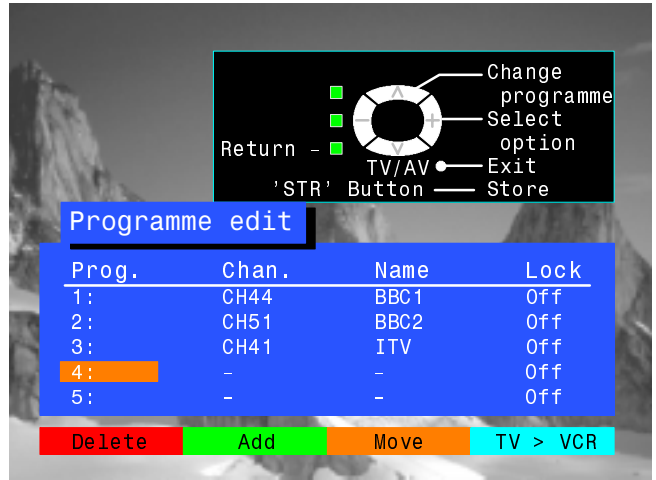

To move a programme to another position

Choose the programme position to be moved



Press the Yellow button on remote control



Choose new position



Press the Yellow button again to confirm



If you have finished in the Programme edit menu, press the TV/AV button to exit

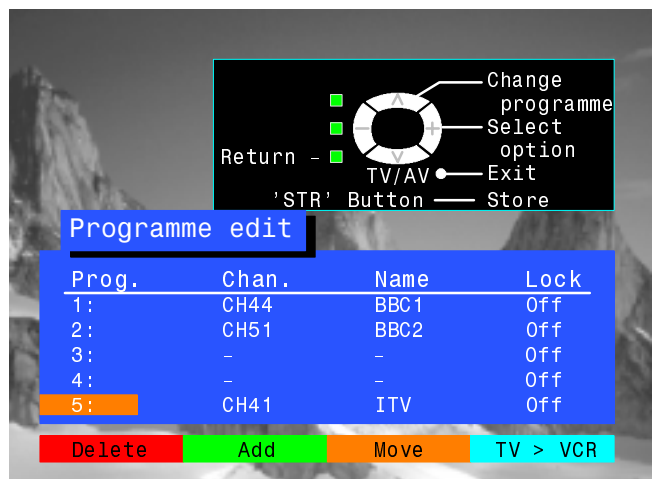
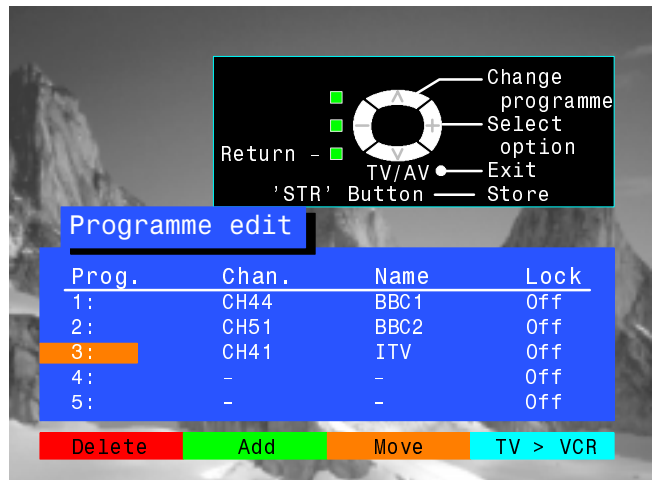

TUNING MENU - PROGRAMME EDIT

To tune a programme position

Choose the programme position



Move to the channel column



Increase or decrease channel number or use the 'C' key for Direct Channel Access (see page 5)



Press STR to store



If you have finished in the Programme edit menu, press the TV/AV button to exit

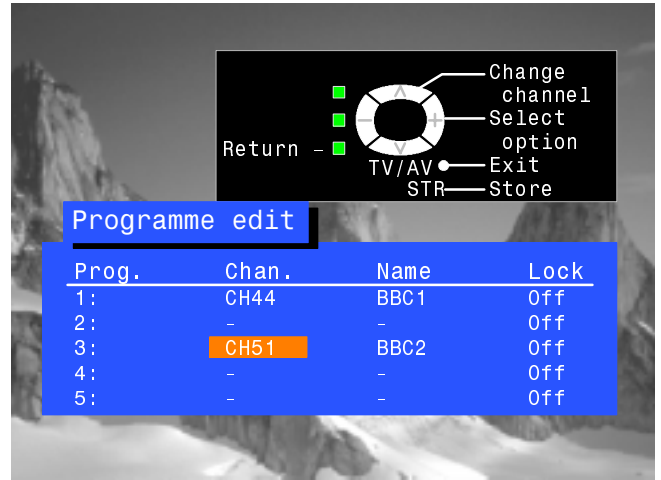

To rename a programme position

Choose the programme position



Move to the Name column



Choose the new character



Move to the next character position



Continue until renaming is done

Press STR to store



If you have finished in the Programme edit menu, press the TV/AV button to exit

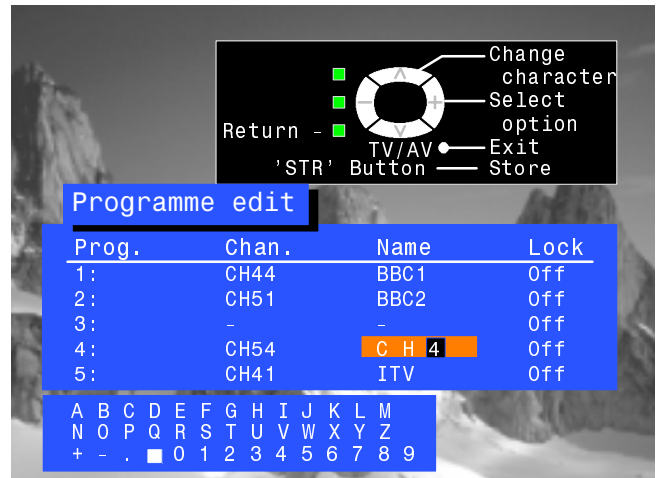

TUNING MENU - PROGRAMME EDIT

To lock a programme position to prevent access

Choose the programme position



Move to the Lock column



Choose between Lock On or Lock Off



Press STR to store



If you have finished in the Programme edit menu, press the TV/AV button to exit



Note :

When a programme position is locked, Direct Channel Access using the 'C' and numeric keys on the remote control is not available

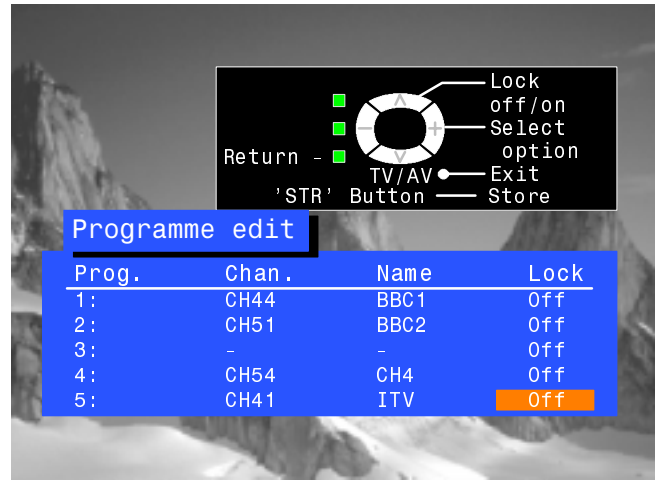

To copy programme information to a compatible VCR connected to AV2

Move to the Prog. column



Press the Blue button on the remote control.

Programme data will now be sent to the VCR. This might take a while, depending on the number of stations stored. If the message "Unable to download, check your VCR" appears on the screen, the television is unable to send programme information to the VCR. See the VCR handbook for further information









If you have finished in the Programme edit menu, press the TV/AV button to exit



TUNING MENU - AUTO SETUP

The Auto setup menu will allow you to automatically retune the TV to your local stations. It is useful if you move to a different region

- Open the Setup menu 
- Move to Tuning menu 
- Access Tuning menu 
- Move to Auto setup 
- Access Auto setup 
- Press to start Auto setup 

The TV will search for, locate and sort into order your local stations. If a compatible VCR is connected via the AV2 socket, programme data will be sent to the VCR via Q-Link (see page 27)

Once this operation is completed the TV will display programme position 1

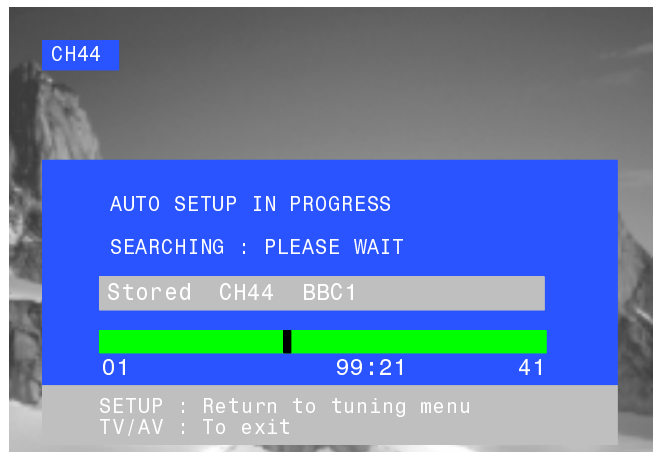
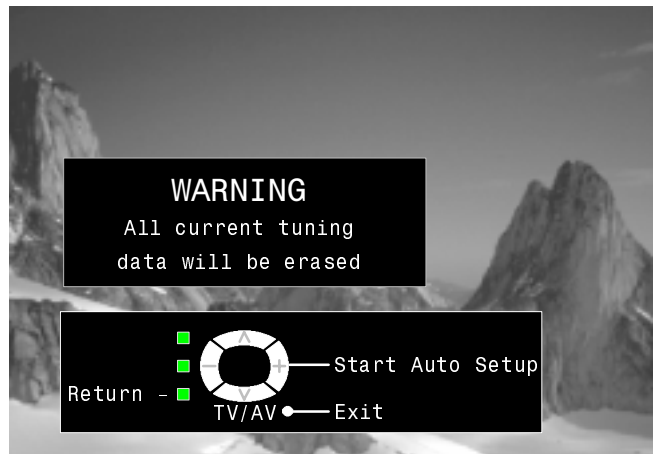
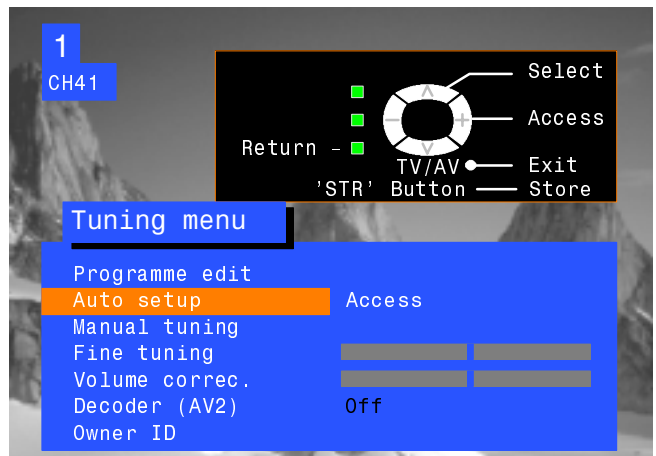
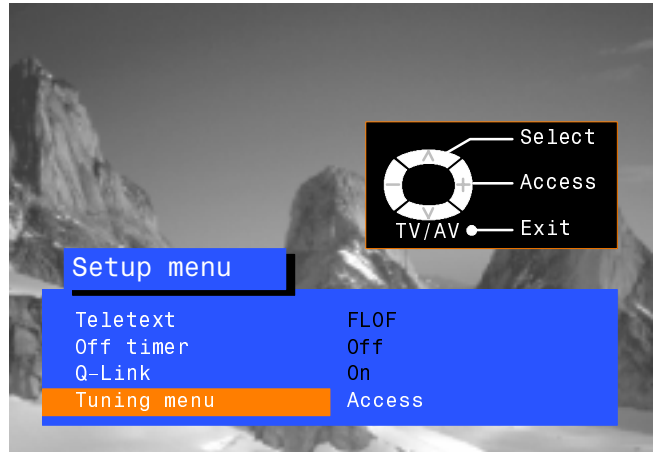

TUNING MENU - MANUAL TUNING

Manual tuning of the programme positions is available either from the On Screen Display menu or from the front panel controls

Manual tuning menu

Open the Setup menu

SET UP



Move to Tuning menu



Access Tuning menu



Move to Manual tuning



Access Manual tuning



Select the programme position to be tuned



Press repeatedly until required station is found



When the desired station is found, press STR to store.



The programme position will flash

Press the TV/AV button to exit

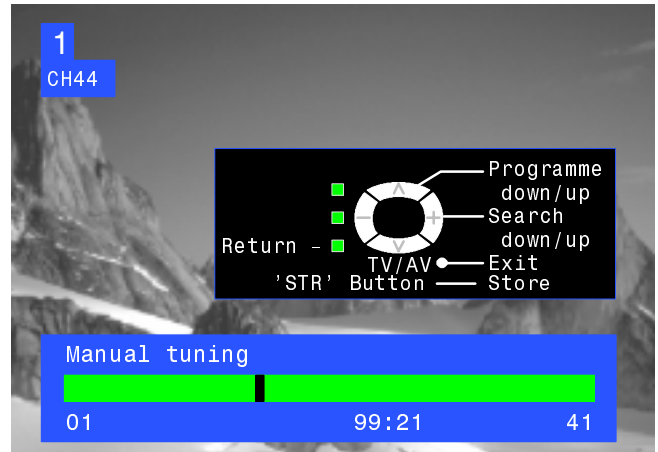
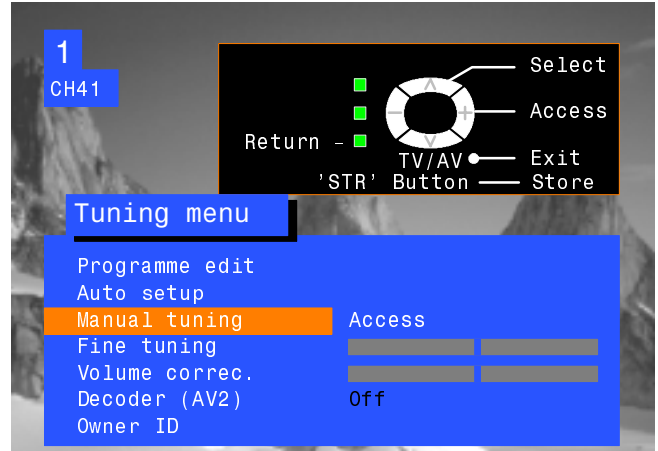

Manual tuning (Front panel)

Press the F button (Front panel) until "Tuning mode" is reached

F



Press the - or + button to access Tuning mode

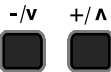

Press the TV/AV button to move between "Change programme" and "Search"



Press the - or + button to change programme position or start search

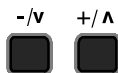

When the desired station is found, press STR to store.



The programme position will flash

Repeat above procedure to tune additional programmes or press the F button to exit



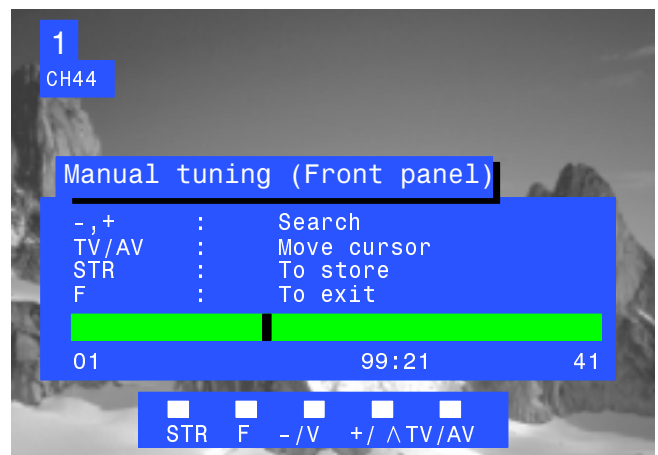











F



TUNING MENU - OWNER I.D.

Owner I.D. allows you to enter a security code and address information so that in the unfortunate event of theft it will help the Police to determine the owner.

If the Owner I.D. information was not entered after Auto setup or it is necessary to alter some of the I.D. information it can be re-accessed via the Tuning menu.

- Open the Setup menu 
 - Move to Tuning menu  
 - Access Tuning menu  
 - Move to Owner I.D.  
 - Access Owner I.D.  
- If the Owner I.D. has previously been set, enter the **PIN NUMBER** (using 0 to 9 on the remote control) followed by **STR** to proceed, this will take you to the **NAME** option
- If no Owner I.D. has previously been set, enter the required 4 digit Owner I.D. **PIN NUMBER** (using 0 to 9 on the remote control)
- If a 4 digit **PIN NUMBER** was entered above, you will be taken automatically to the **NAME** line
- If not, move to the **NAME** line
- Change character  
 - Select character position    
- Repeat above until **NAME**, **HOUSE NUMBER** and **POSTCODE** are entered
- Press **STR** to store the details. Press again, to confirm, when asked, "Are you sure ?"
- The Tuning menu will be displayed
- Press the **TV/AV** button to exit

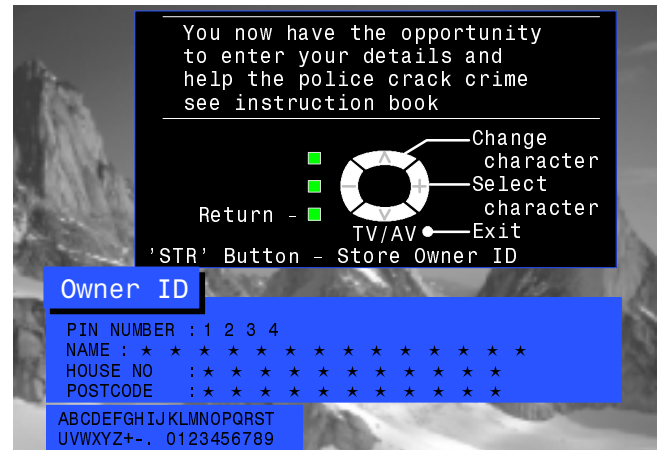
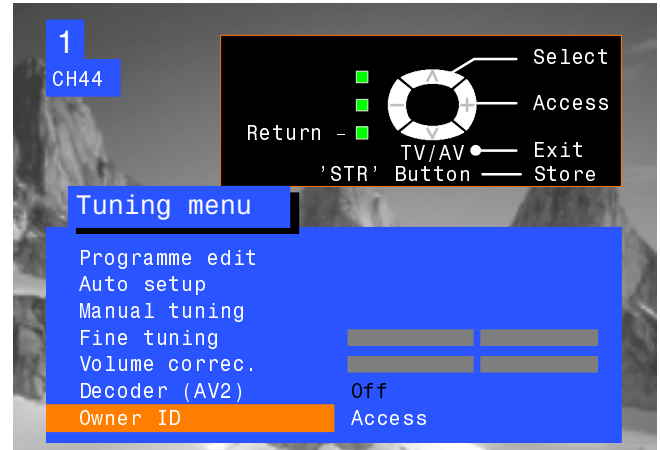
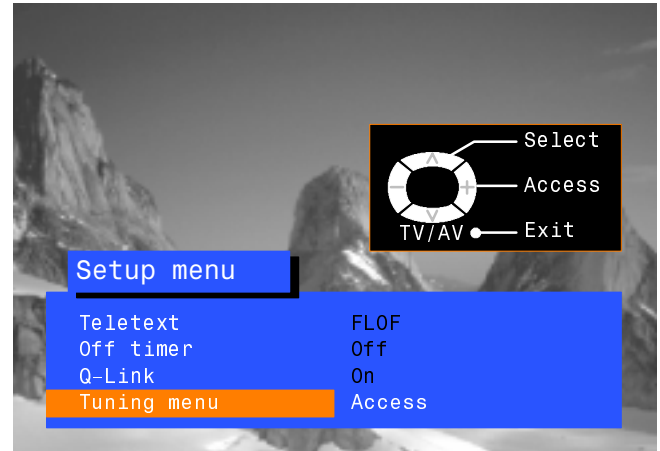

For future reference, write your PIN Number here :

AV SELECT AND SETUP

The AV Select menu will allow you to choose which AV source to view

Press the TV/AV button



Press the appropriate coloured remote control button (whilst the options remain on screen)



The options will disappear

You may wish to make adjustments in the Setup or Sound menus

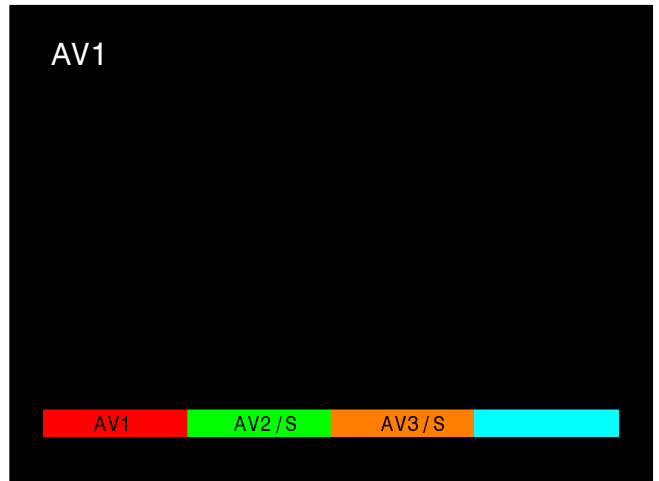

Setup menu

Open the Setup menu



Move to your choice



Access adjustments or options



Press the TV/AV button to exit

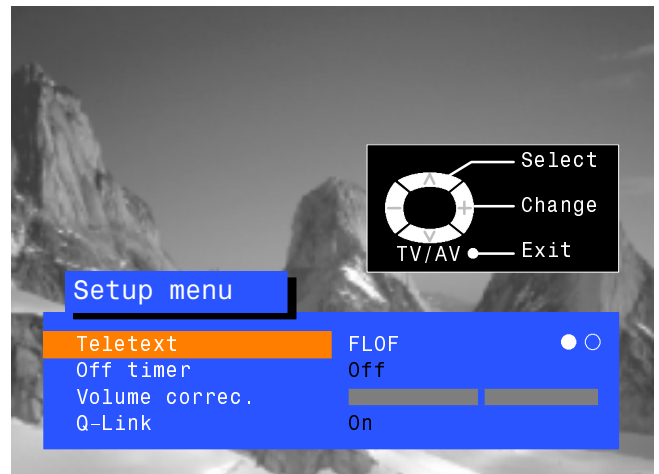

Sound menu

Open the Sound menu



Move to your choice



Access adjustments or options



Press the TV/AV button to exit

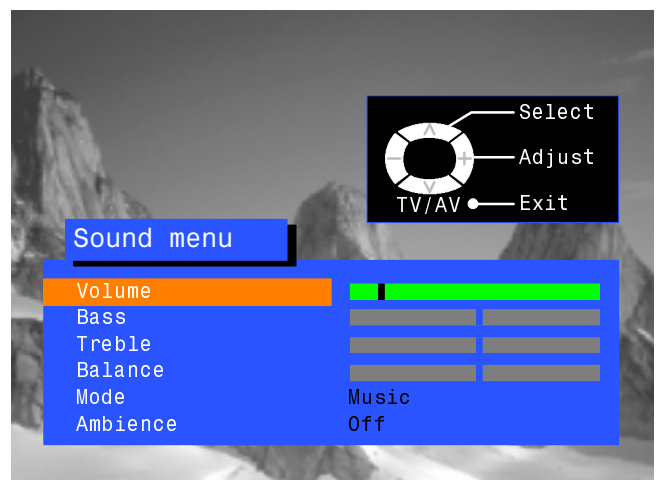

Q-Link allows the television to communicate with a compatible VCR

For Q-Link communication to work, the TV must be connected to a VCR with the "Q-Link", "NEXTVIEWLINK", "DATA LOGIC", "Easy Link", "Megalogic" or "SMARTLINK" logo using a "fully wired" Scart cable between the AV2 socket of the television and the appropriate socket on your VCR.

For connection to the appropriate Scart socket on the VCR, refer to the VCR operating instruction book.

When using a "NEXTVIEWLINK" VCR the main features possible are the following :

- *Preset Download* - Downloading of tuning information from the TV to the VCR .
- *Direct TV Record* - For immediate recording of the current program (What You See Is What You Record).

When using a "Q-Link" VCR the main features possible are the following :

- *Preset Download* - Downloading of tuning information from the TV to the VCR .
- *Direct TV Record* - For immediate recording of the current program (What You See Is What You Record).
- *TV/VCR Auto Power On* - When the VCR plays a tape the TV will automatically switch On and select the AV2 input.
- *VCR Auto Power Standby* - When the TV is switched into Standby, the VCR will also switch into Standby.
- *VCR Image view* - When the VCR plays a tape the TV will automatically switch On and select the AV2 input.

This TV will also communicate with other VCR's that bear the following logos :

- "DATA LOGIC" (a trademark of Metz Corporation).
- "Easy Link" (a trademark of Philips Corporation).
- "Megalogic" (a trademark of Grundig Corporation).
- "SMARTLINK" (a trademark of Sony Corporation).

These VCR's may support some or all of the above functions.

Refer to the VCR operating instruction book.

Preset Download

This allows the programme order from the TV to be downloaded to the VCR, this helps to ensure that correct recordings are made, there are several ways to perform this operation :

1. During installation as explained in the 'Quick Start Guide' beginning on page 6.
2. When Auto setup is started from within the Tuning menu, see page 23.
3. When TV to VCR manual download is started from within 'Programme edit', see page 22.
4. Preset download started from the VCR, refer to the VCR operating instruction book.

Important Note:

Not all VCRs support this type of data communication system. Some may support certain features, but not others. Refer to the VCR operating instruction book.

If Q-Link is inoperative, first confirm that your Scart cable is a "fully wired" type. Ask your dealer for further details.

What You See Is What You Record (DIRECT TV RECORDING)

This will allow the immediate recording of the program currently shown on the Television.

Press the DIRECT TV REC button on the remote control



If the VCR is in Standby mode with a useable tape inserted, it will automatically switch on when you press the DIRECT TV REC button.

If a "Q-Link" VCR is connected a message will appear on the TV screen showing what is being recorded, or if it is not possible to record. Some "Q-Link" compatible VCR's will only display the message when on the VCR programme position(0) or in AV mode. Refer to the VCR operating instruction book.

VCR recording preset prog

Recording this programme now

VCR is recording the programme signal from its own tuner. If you wish you can switch off the TV and leave the VCR recording in the normal way.

VCR recording TV source

VCR is recording the programme signal from the television. You must not change programme position or switch off the TV: if you do, the VCR will automatically stop recording and switch off.

No recording - TAPE IS PROTECTED

The write protection tab on the back of the cassette has been removed.

Examples of other messages that might be displayed are:

No recording - NO TAPE

No recording - VCR IS PLAYING

VCR Recording VCR external

No recording - ALREADY RECORDING!

No recording - TAPE MAY BE DAMAGED

No recording - NO SOURCE AVAILABLE

TV / VCR Auto Power On

(With a Panasonic Q-Link VCR connected, this additional feature is available).

- If you insert a tape in the VCR and press the Play button whilst the TV is in 'Standby' mode, the TV will automatically switch On and select the AV2 input so that you can view the tape.

Some other VCR's may support this feature. Refer to the VCR operating instruction book.

VCR Auto Power Standby

(With a Panasonic Q-Link VCR connected, this additional feature is available).

When the TV is switched into 'Standby' mode, the VCR will also switch into 'Standby' mode if there is no tape in the VCR, or if there is a tape in and the VCR is in 'Rewind' or 'Stop' mode (if the VCR is rewinding a tape, it will not switch into 'Standby' mode until rewinding has finished).

Some other VCR's may support this feature. Refer to the VCR operating instruction book.

VCR Image View On

(With a Panasonic Q-Link VCR connected, this additional feature is available).

If the TV is in Standby mode and the VCR sends a menu to be displayed on the TV screen (e.g. Main menu), the TV will automatically switch On and the menu will be displayed.

Some other VCR's may support this feature. Refer to the VCR operating instruction book.

VCR AND SATELLITE RECEIVER INSTALLATION

Your new TV is supplied with programme position '0' set to receive an RF signal from your VCR, although a Scart connection is preferable if the VCR is so equipped.

However, if for some reason your VCR is tuned to a different RF channel then you will not receive any picture or sound from your VCR on programme position '0' of the TV. It will be necessary to either adjust the RF channel of your VCR (some VCR's allow adjustment of their RF channel via their remote control unit) or to adjust the tuning of the TV's programme position '0' or both until it receives the RF output channel of your VCR.

It is intended that this advice is used in conjunction with the instruction books for your additional equipment.

Use the AV1 Scart terminal for a VCR.

Use the AV2S Scart terminal for an S-Video VCR.

Use the AV2S Scart terminal for a Q-Link, NEXTVIEWLINK or compatible VCR.

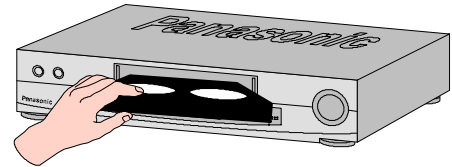

To tune your TV to the VCR

Switch on the VCR, insert and play a pre-recorded tape with known content

Open the Setup menu

SET UP



Move to Tuning menu



Access Tuning menu



Move to Manual tuning



Access Manual tuning



Select programme position '0' VCR



Start searching for the VCR playback of the known content tape



When the VCR playback is found, press STR to store



Press the TV/AV button to exit



See below for installation of VCR and Satellite Receiver

Notes :



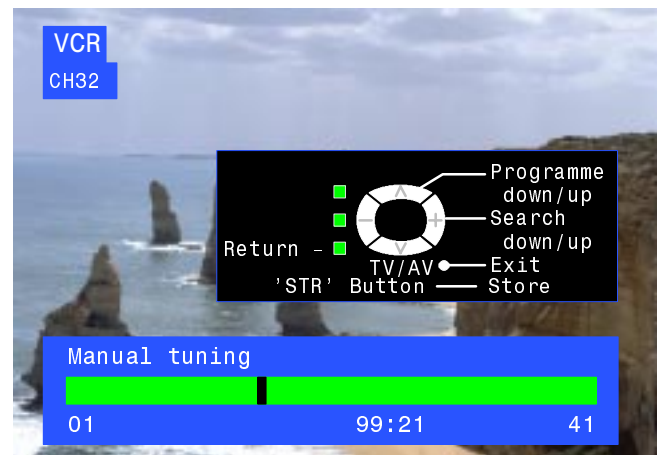
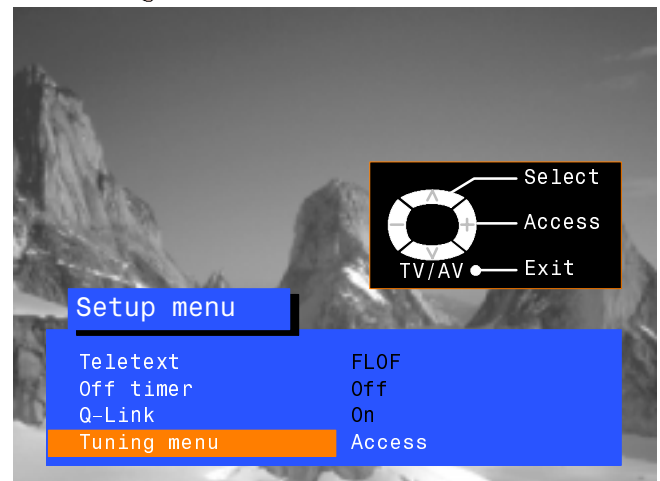





- If picture patterning occurs on programme position '0' it may be necessary to adjust the RF output channel of the VCR, refer to the VCR instruction book.
- If a Satellite Receiver and a VCR are going to be used with RF cable connections **it is important** to avoid both units being set on the same channel. Refer to the Satellite Receiver and VCR instruction books for precise tuning information.



VCR / DVD OPERATION

The Remote Control is capable of operating some functions of selected Panasonic VCRs and DVD (Digital Versatile Disc) equipment. Some VCR and DVD equipment have different functions, so to ensure compatibility please refer to the equipment's instruction book or consult your dealer for details.



| | |
|---|---|
|  | <p>Standby Press to switch the VCR or DVD to standby mode. Press again to switch back on.</p> |
|  | <p>VCR / DVD switch Use this switch to select whether controls operate DVD equipment or your VCR.</p> |
|  | <p>Play Press to playback the tape or DVD.</p> |
|  | <p>Stop Press to stop the tape or DVD.</p> |
|  | <p>Skip / Fast Forward / Cue VCR: Press to fast forward the tape. In Play mode, press to view the picture rapidly forward (Cue). DVD: Press once to skip to the next track. In play mode press and hold to view the picture rapidly forward.</p> |
|  | <p>Skip / Rewind / Review VCR: Press to rewind the tape. In Play mode, press to view the picture rapidly in reverse (Review). DVD: Press once to skip to the previous track. In play mode press and hold to view the picture rapidly in reverse.</p> |
|  | <p>Pause / Still Press in playback mode, the picture will pause. Press again to restart play.</p> |
|  | <p>Programme Up / Down Press to increase or decrease the VCR programme position by one.</p> |
|  | <p>Record Press this button to start recording.</p> |

TELETEXT OPERATION

- Teletext features may vary depending on the Broadcasting Companies and is only available if the channel selected is transmitting Teletext.
- Pressing the Picture button whilst in Teletext operation will display the contrast function with a cyan bar, press ◀ ▶ to alter the setting as required.
Pressing the Setup button whilst in Teletext operation will display special function options at the bottom of the screen.
- When in Teletext mode, the volume may still be altered to the desired listening level.

What is LIST mode ?

In LIST mode, four differently coloured page numbers are situated at the bottom of the screen. Each of these numbers can be altered and stored in the TV's memory.

What is FLOF (FASTEXT)?

In FASTEXT mode, four differently coloured subjects are situated at the bottom of the display. To access more information about one of these subjects, press the appropriately coloured button. This facility enables fast access to information on the subjects shown.

TV/TEXT



TV / Teletext mode

Press the **TV/TEXT** button.
The screen will display the Teletext page.
Press again when you wish to return to TV mode.

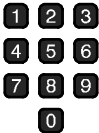

Page Selection

Pages can be selected in two ways :

- Press the Up / Down buttons to increase or decrease the page number by one.
- By entering the page number, using 0 - 9 on the remote control.

SET UP



Full / Top / Bottom

Press the **SET UP** button to display special functions, followed by the **Green** button.
Press the **Green** button again to expand the BOTTOM half.
Press again to return to normal (FULL) size.

SET UP



Reveal

Press the **SET UP** button to display special functions, followed by the **Red** button to reveal hidden words e.g. quiz page answers. Press again to hide.



Red / Green / Yellow / Blue buttons

In FASTEXT mode these correspond to the differently coloured subjects.
In LIST mode they correspond to the differently coloured page numbers.

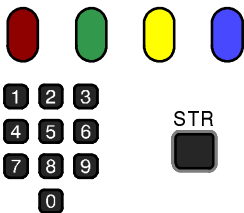

List Store

In LIST mode the four page numbers can be altered (programme positions 1 - 25 only).
To do this, press one of the four coloured buttons and enter the new page number.
Press and hold **STR**, the page numbers will change to white indicating that the page is stored.

HOLD



Hold

To hold the Teletext page when viewing multi-page information.
Press again to return to automatic page update.

TELETEXT OPERATION

It is not possible to change the programme position when in News flash, Update or Sub Coded Page Access operation.

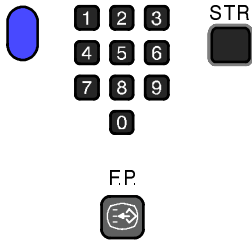

Favourite Page (F.P.)

Stores a favourite page in memory for instant recall. To store such a page, the TV must be in LIST mode, and the programme position must be from 1 - 25.

Press the **Blue** button, select the page number, then press and hold the **STR** button. The page number is now stored.

Press **F.P.** to recall this page.

Update Display

Press the **SET UP** button to display special functions, followed by the **Yellow** button to view the TV picture whilst searching for a Teletext page.

When found, the screen will display the page number at the top left.

Press the **Yellow** button to view the page.

Press **TV / TEXT** again to return to normal TV operation.



News Flash

When a news flash page has been selected, press **SET UP, Yellow**, to view the TV picture. When an update is received, the page number will be displayed on screen.

Press the **Yellow** button to display the News Flash

Press **TV / TEXT** to return to normal TV operation.

Update

Press **SET UP, Yellow** to see the update of information on certain pages.

When an update is received, the page number will be displayed at the top left of the screen.

Press the **Yellow** button to view the page.

Press **TV / TEXT** to return to normal TV operation.



Sub Coded Page Access

When Teletext information exceeds more than one page, it may take some time for the automatic changing of the sub pages to reach the sub page you require.

It is possible to enter your required sub page and continue watching the normal programme until the correct sub page is found.

Select the required page number using buttons 0 - 9.



Press the **SET UP** button followed by the **Blue** button; T**** will be displayed at the top right of the screen.

Enter desired sub page number before the T**** disappears.

To select page 6 enter 0, 0, 0 and 6.

(If in LIST mode, a 'T' will appear in the current box at the bottom).



Press the **Yellow** button to view a normal TV programme.
(Press **SET UP, Yellow** in LIST mode).

When the page is available, press the **Yellow** button to view the page.

To clear the page perform one of the following :

- Press **SET UP**.
- Select a new page number.
- Press **TV/TEXT** to return to normal TV operation.



Index

When in FASTEXT operation

Press **INDEX** to return to the main index page.

Depending on the way information is transmitted, this may have to be pressed more than once to return to the main index page.

AUDIO / VIDEO CONNECTIONS

Front AV3 4 Pin S-Video, RCA Audio / Video and Headphone sockets

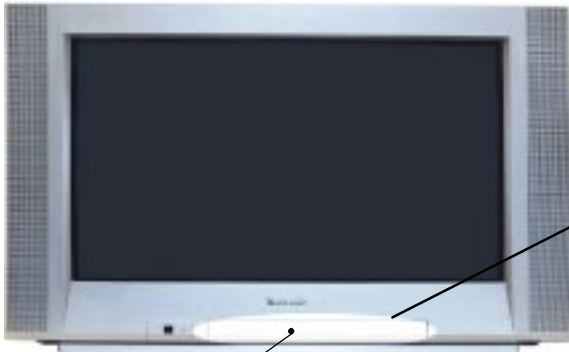

Press and release to open

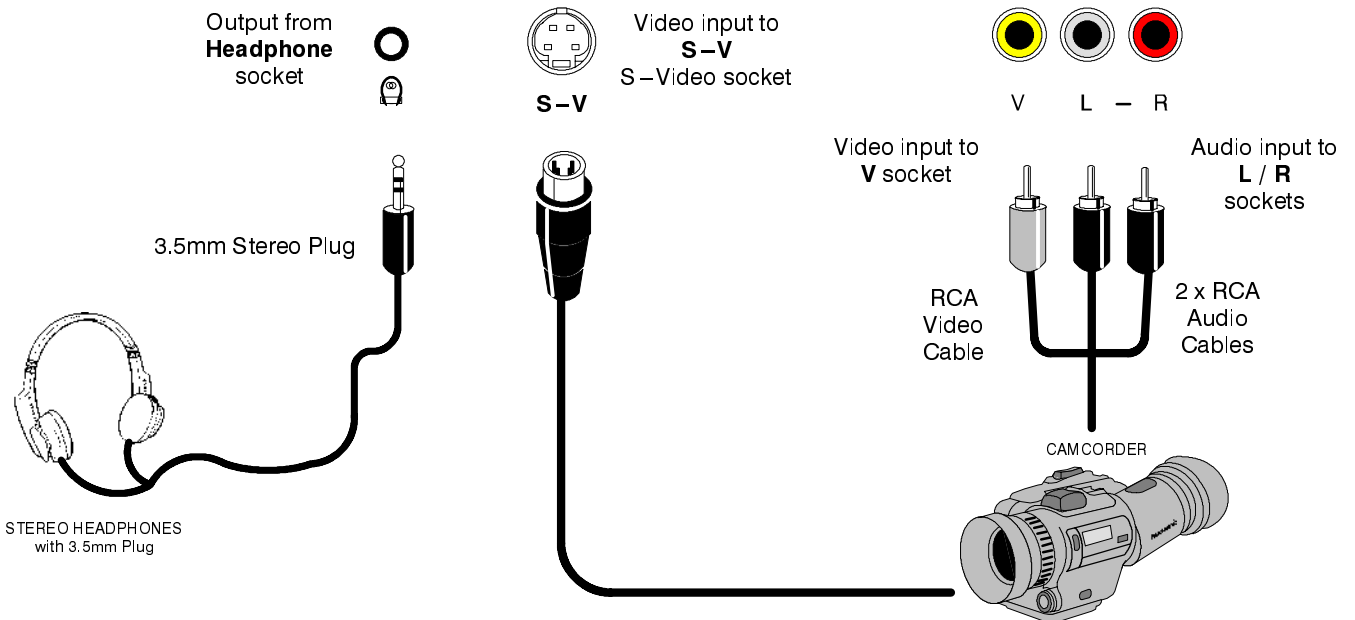

Note :
Additional equipment and cables shown are not supplied with this TV set

■ Scart socket information

AV1 Scart socket

| | | | | |
|------------------|----|--|----|------------------|
| Socket Earth | 21 | | 20 | CVBS in (video) |
| CVBS out (video) | 19 | | 18 | RGB status earth |
| CVBS earth | 17 | | 16 | Status RGB |
| Red in | 15 | | 14 | Earth |
| Red earth | 13 | | 12 | -- |
| Green in | 11 | | 10 | -- |
| Green earth | 9 | | 8 | Status CVBS |
| Blue in | 7 | | 6 | Audio in (L) |
| Blue earth | 5 | | 4 | Audio earth |
| Audio out (L) | 3 | | 2 | Audio in (R) |
| Audio out (R) | 1 | | | |

Suitable inputs for **AV1** include RGB (Red/Green/Blue)

AV2 Scart socket (S-Video, Q-Link)

| | | | | |
|------------------|----|--|----|-----------------|
| Socket Earth | 21 | | 20 | CVBS in (video) |
| CVBS out (video) | 19 | | 18 | Earth |
| CVBS earth | 17 | | 16 | -- |
| S.C. - in | 15 | | 14 | Earth |
| Earth | 13 | | 12 | -- |
| -- | 11 | | 10 | Q-Link data |
| Earth | 9 | | 8 | Status CVBS |
| -- | 7 | | 6 | Audio in (L) |
| Earth | 5 | | 4 | Audio earth |
| Audio out (L) | 3 | | 2 | Audio in (R) |
| Audio out (R) | 1 | | | |

AV2 - Pins 15 and 20 are dependent on AV2 S-VHS / VIDEO switching

S-Video 4 pin socket

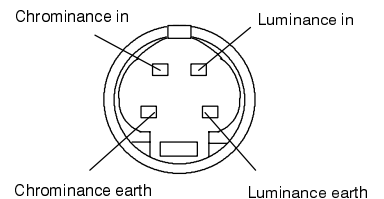





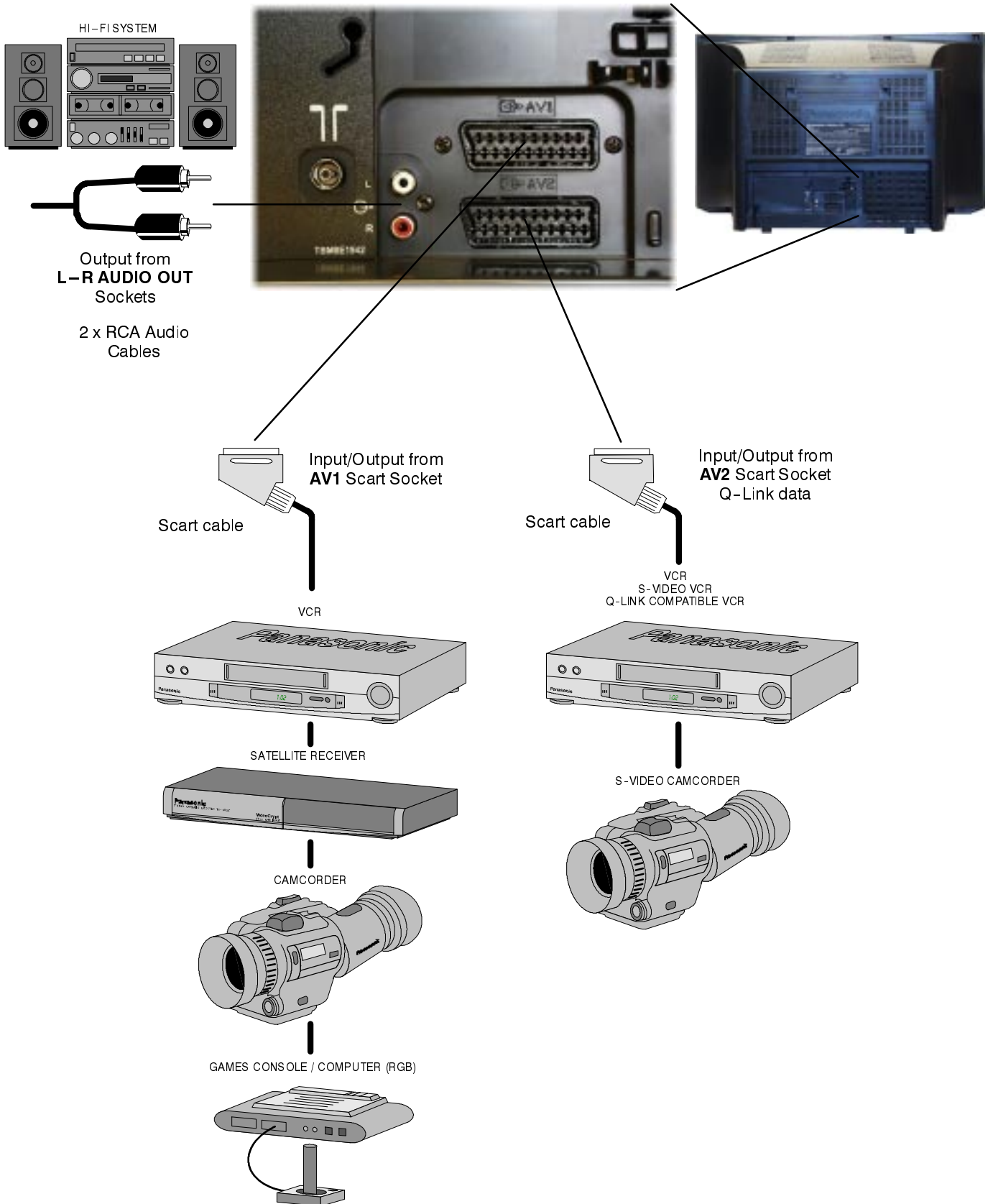

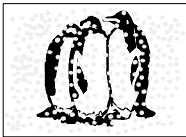
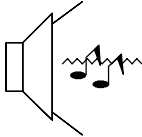

AUDIO / VIDEO CONNECTIONS

Rear AV1/AV2(S) 21 Pin Scart and RCA Audio Out terminals

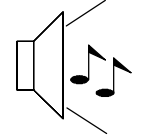
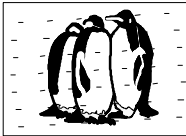
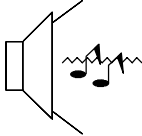

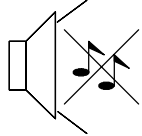
Notes:
 Additional equipment and cables shown are not supplied with this TV set.
 Do not connect a computer with TTL output (5V) to this set.

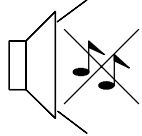
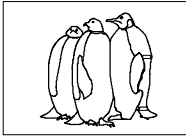
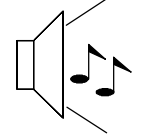
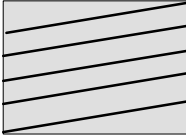
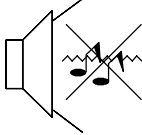
TROUBLESHOOTING

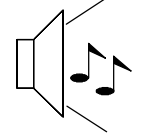
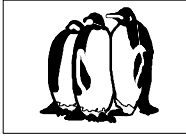
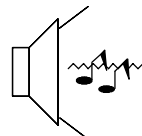
| Symptoms | | Checks |
|--|--|--|
| Picture | Sound | |
|  Snowy Picture |  Noisy Sound | Aerial location, direction or connection |
|  Multiple Images |  Normal Sound | Aerial location, direction or connection |
|  Interference |  Noisy Sound | Electrical appliances Cars / Motorcycles Fluorescent lights Switch on P-NR in Picture menu to reduce picture noise |
|  Normal Picture |  No Sound | Volume level Sound mute switched on |
|  No Picture |  No Sound | TV set to AV mode Not plugged into A.C. outlet Not switched on Picture / Sound controls set at minimum levels Check if in standby mode |
|  No Colour |  Normal Sound | Colour controls set at minimum levels |
|  Poor or Distorted Picture |  Weak or No Sound | Retune Channel(s) |
|  Coloured Patches |  Normal Sound | Magnetic Interference from unshielded equipment Receiver moved while switched ON, switch TV off for 30 minutes. If picture is also tilted, use Geomagnetic Correction feature (see Quick Start Guide, page 11) |
|  Normal Picture |  Weak or distorted sound | Sound reception may have deteriorated. Switch NICAM setting (Sound menu) to Off until reception improves. |

FOR YOUR GUIDANCE

■ Service

Before requesting service, please refer to the trouble-shooting guide on previous page to determine the symptoms. To obtain service please contact your local Panasonic dealer quoting the model number and serial number (both are located at the rear of the TV).

■ TV Games / Home Computers

Extended use of TV games or home computers with any television set can cause a permanent 'shadow' on the screen. This type of irreversible picture tube damage, can be limited by observing the following points:

- Reduce the brightness and contrast levels to a minimum viewing level.
- Do not operate the television set for a continuous period of time while using TV games or home computers.
- This type of picture tube damage, is not an operating defect, and as such is not covered by the Panasonic warranty.

■ Last Position Memory

Certain functions have a last position memory, i.e. the setting at the time of switch-off will be the setting used when the receiver is switched on again:-

| | |
|----------------|------------------------------|
| Programme | Tint (M.NTSC / NTSC only) |
| Mode | Volume correction |
| AV Position | Contrast |
| Volume | Sharpness |
| NICAM | Aspect mode |
| Bass | Standby |
| Treble | Artificial Intelligence (AI) |
| Balance | Colour |
| Colour Balance | Brightness |
| Status | P-NR |
| Teletext mode | Decoder (AV2) |
| Ambience | |

■ Sleep Feature

If the set is not switched off when the TV station stops transmitting, it will automatically go to standby mode after 30 minutes. This function will not operate when the TV is in AV mode.

SPECIFICATIONS

| | | TX-32DK1L | |
|---|---|--|--|
| Power Source | | 220 - 240V 50Hz A.C. | |
| Power Consumption | | 95W | |
| Standby Consumption | | 1.4W | |
| Picture Tube Visible Diagonal | | 76 cm | |
| Audio Output Music Power | | Front Left / Right 15W x 2, 8Ω impedance | |
| Dimensions | H | 561.0 mm | |
| | W | 896.0 mm | |
| | D | 558.5 mm | |
| Weight (Kg) | | 47 | |
| Receiving Systems/ Band name | PAL I PAL 525/60 M.NTSC NTSC (AV input only) | UHF E21 - 68, VHF A1 - S20, S21 - S41 (Hyperband) Playback of NTSC tape from some PAL Video recorders (VCR) Playback from M.NTSC Videorecorders (VCR) Playback from NTSC Videorecorders (VCR) | |
| Aerial - Rear | | UHF / VHF | |
| Headphones - Front | | 3.5mm, 8Ω impedance | |
| AV - Rear | | AV1 - 21 pin terminal - Audio / Video in / out, RGB in AV2 - 21 pin terminal - Audio / Video in/out, S-Video in, Q-Link 2 x RCA Audio Monitor Out | |
| AV - Front | | AV3 - S - Video in, RCA Audio / Video in | |

Specifications are subject to change without notice. Weight and dimensions shown are approximate.

Panasonic Ireland Ltd

Burton Hall Road,
Sandyford Industrial Estate,
Dublin 18

99X